



**DOOR HARDWARE**  
PRODUCT CATALOGUE





## INTRODUCTION

Lockron Architectural Hardware is a leading supplier of architectural hardware products in the UK established with a vision to provide improved quality locking solutions, which are aesthetically designed as well as functionally suited to fulfil the requirements of esteemed clients.

Being a leading door hardware manufacturer, we understand the different needs of our esteemed customers and our wide range of products caters to their expectations by meeting all their requirements.

With our knowledge base and expertise to produce an extensive range of high-quality door hardware solutions for architects, designers, contractors, builders and end-users, the company has quickly become recognized as one

of the world's most innovative designers and producers of architectural door hardware. We closely work with architects, designers and specifiers to provide exclusive products that complement and enhance their design ideas.

Lockron offers an extensive selection of reliable, quality door hardware, including door closers, locks, hinges, exit devices, glass fittings, furniture fittings, security hardware and more. Every product is designed to stand the test of time and to endure the rigours of life on buildings throughout the world. Each product is manufactured to meet global industry standards and is certified by internationally accredited third-party testing houses such as Certifire, Intertek and UL. Coupled with regional offices, warehouses, and large inventory, we provide fast and reliable service to our customers throughout the globe.



---

**WHAT OUR  
SYMBOLS MEAN..**

1



**BS EN 1634-1**

Fire resistance tests for door and shutter assemblies

2



**BS EN 1935**

British/European standard requirement for single axis hinges

3



**BS EN 1154**

British/European standard requirement for controlled door closing devices

4



**BS EN 1155**

British/European standard requirement for electronically powered hold open devices

5



**BS EN 1158**

British/European standard requirement for door coordinator devices

6



**BS EN 12209**

British/European standard requirement for locks, latches and locking plates

7



**BS EN 1303**

British/European standard requirement for cylinder locks

8



**BS EN 1906**

British/European standard requirement for lever handles and knob furniture

9



**BS EN 1125**

British/European standard requirement for panic exit devices operated by horizontal bar

10



**BS EN 179**

British/European standard requirement for panic exit devices operated by push pad or lever handle devices

**BS EN 1670**

British/European standard requirement for corrosion resistance of door hardware



11

**BS 8300**

Design of buildings and their approaches to meet the needs of disabled people



12

**CE MARKING**

Ensures that the product is in conformity with the essential requirements of the applicable construction products directive



13

**FIRE SYMBOL**

Suitable for use on fire doors



14

**UL LISTING**

Underwriters laboratories is an independent third party certification scheme that assures performance, quality, reliability and traceability of fire protection products.



15

**CERTIFIRE**

Certifire is an independent third party certification scheme that assures performance, quality, reliability and traceability of fire protection products.



16

**INTERTEK**

Intertek is an independent third party certification scheme that assures performance, quality, reliability and traceability of fire protection products.



17

**10 YEAR MECHANICAL GUARANTEE**

Products guaranteed for 10 years against any manufacturing defect



18

**2 YEAR MECHANICAL GUARANTEE**

Products guaranteed for 2 years against any manufacturing defect



19

**LOCKRON**

From Entries To Exits











---

# PRODUCT FINISHES

We produce hardware and accessories in a variety of finishes designed to suit your every need.

## STANDARD FINISHES

<b>PB</b>	Polished Brass	
<b>SB</b>	Satin Brass	
<b>PC</b>	Polished Chrome	
<b>SC</b>	Satin Chrome	
<b>AB</b>	Antique Bronze	
<b>PSS</b>	Polished Stainless Steel	
<b>SSS</b>	Satin Stainless Steel	
<b>PNP</b>	Polished Nickel Plated	
<b>SNP</b>	Satin Nickel Plated	

## PVD FINISHES

<b>PVDG</b>	PVD Gold	
<b>PVDB</b>	PVD Matt Black	
<b>PVDSRG</b>	PVD Satin Rose Gold	
<b>PVDPRG</b>	PVD Polished Rose Gold	
<b>PVDSB</b>	PVD Satin Brass	
<b>PVDPB</b>	PVD Polished Brass	
<b>PVDAB</b>	PVD Antique Bronze	

## POWDER COATED FINISHES

<b>SIL</b>	SILVER	
<b>BLK</b>	BLACK	
<b>WHT</b>	WHITE	



Our in-house design personnel are completely qualified in all areas of design and production, and we always strive to provide cutting-edge, aesthetically pleasing, and affordable hardware while only settling for the best possible quality. Stress analysis, environmental factors, and material considerations are all taken into account when evaluating designs for strength. Through the work of the design team, we can turn your ideas into high quality products in a short space of time.

## **DOOR** HARDWARE

LEVER HANDLES	12
PULL HANDLES	32
LOCKS AND LATCHES	39
CYLINDERS AND KEYS	58
HINGES	63
DOOR CONTROLS	70
PANIC HARDWARE	82
ACCESSORIES	88

## **FURNITURE** FITTINGS

CABINET HINGES	127
DRAWER RUNNERS	134
CABINET HANDLES	139
CABINET KNOBS	148
CABINET ACCESSORIES	156

## **GLASS** FITTINGS

PATCH FITTINGS	166
PULL HANDLES	172
FLOOR SPRING	178
GLASS DOOR LOCKS	180
GLASS DOOR HINGES	182
SHOWER FITTINGS	184



# LEVER HANDLES

Lockron Lever handle series consists of Hollow and Solid designs made exclusively from 304 grade stainless steel. All designs feature a 52mm diameter push on rose.



Featured Product

**LIL011 SB**

**Available** Rose Designs

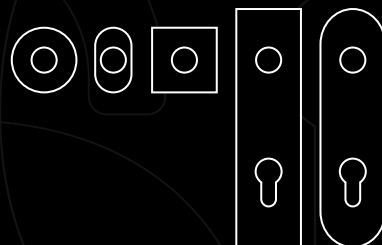

## LEVER HANDLES

Lockron Grade 3 lever handles are suitable for High frequency of use by public or others with little incentive to exercise care and with a high chance of misuse, e.g. public office doors.

### FEATURES

- Spring assisted lever handles
- Stainless Steel SS304 Grade
- 52mm push on rose with 8mm projection as standard
- Tested for 200,000 cycles
- Suitable for use on fire/smoke door assemblies
- Add suffix S for same design on Square rose and Square escutcheons

### PACKAGING INCLUDES

- 52mm escutcheons prepared for Euro-profile cylinders 8mm x 8mm square Pitts spindle
- Back to back fixing screws and grub screws



### QUALITY AND PERFORMANCE

Successfully inhouse type tested for conformity to all the requirements of BS EN1906

### FINISHES

SSS	Satin stainless steel
PSS	Polished stainless steel
PVDB	PVD Black
PVDG	PVD Gold

\*Special finish available upon request

\*SS316 available upon request

**PRODUCT CODE**

LIL001

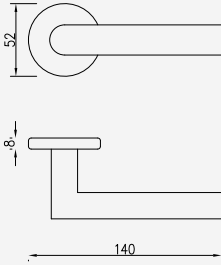

**PRODUCT CODE**

LIL002

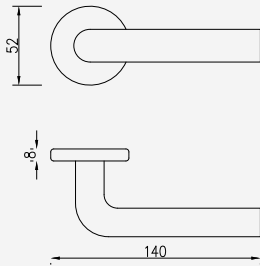

**PRODUCT CODE**

LIL003

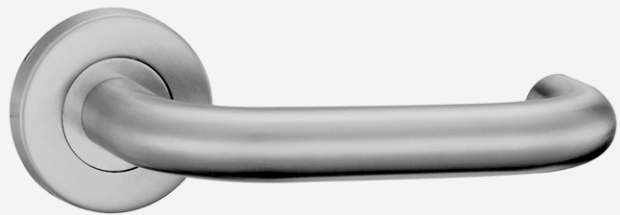
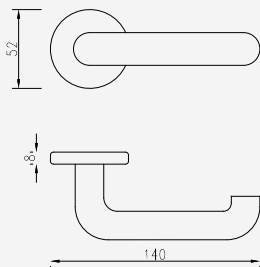

**TUBULAR LEVER HANDLES**

DOOR HARDWARE

**PRODUCT CODE**

LIL004

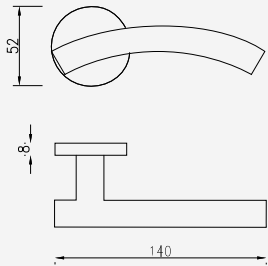

**PRODUCT CODE**

LIL005

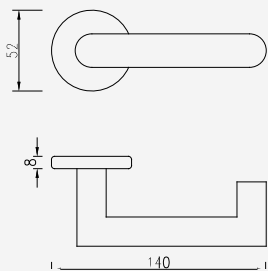

**PRODUCT CODE**

LIL006

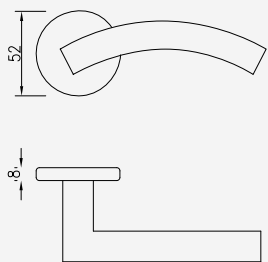

**PRODUCT CODE**

LIL007

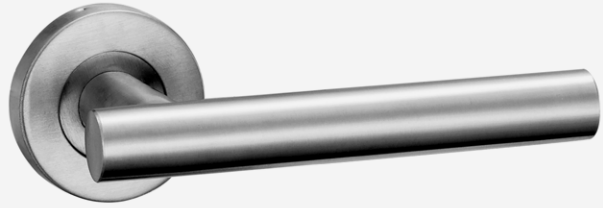
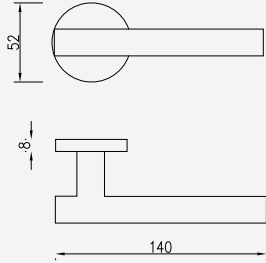

**PRODUCT CODE**

LIL008

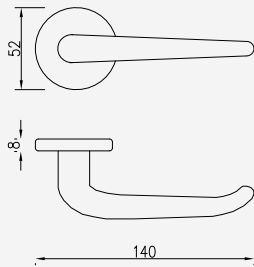

**PRODUCT CODE**

LIL009

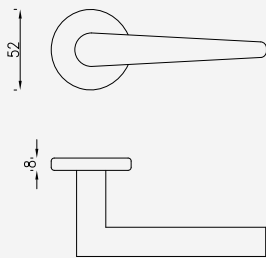

TUBULAR LEVER HANDLES

DOOR HARDWARE

PRODUCT CODE

LIL010

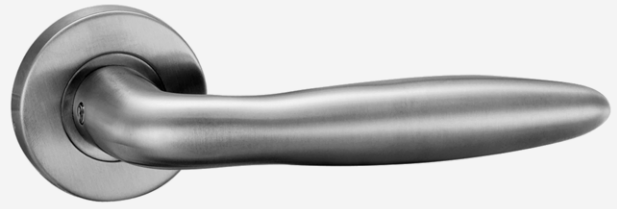
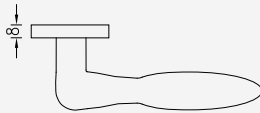
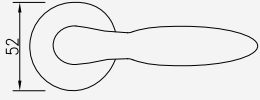

PRODUCT CODE

LIL011

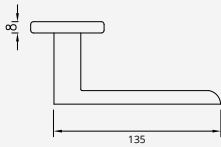
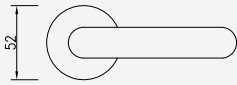

PRODUCT CODE

LIL012

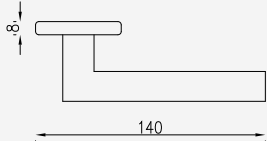
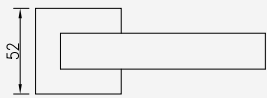

**PRODUCT CODE**

LIL013

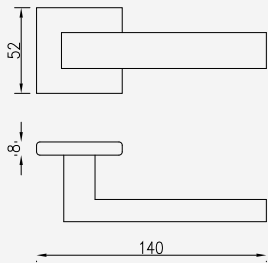

**PRODUCT CODE**

LIL014

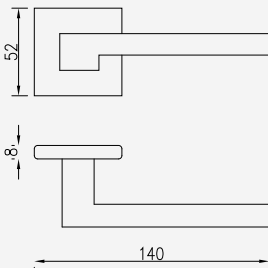

**PRODUCT CODE**

LIL015

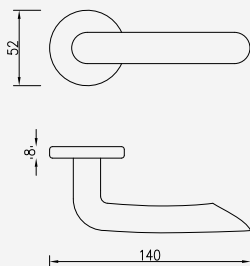

**TUBULAR LEVER HANDLES**

DOOR HARDWARE

**PRODUCT CODE**

LIL016

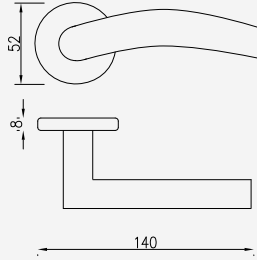

**PRODUCT CODE**

LIL017

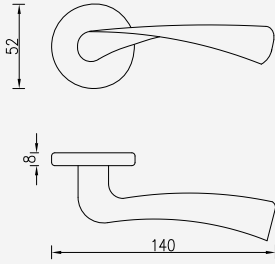

**PRODUCT CODE**

LIL018

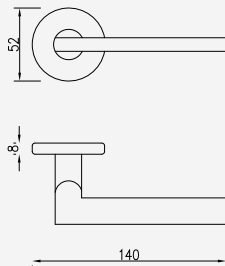

**PRODUCT CODE**

LIL019

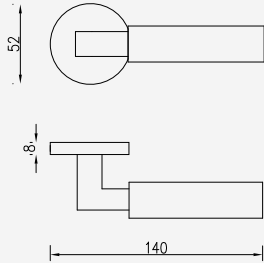

**PRODUCT CODE**

LIL020

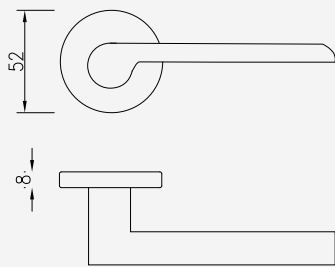

**PRODUCT CODE**

LIL021

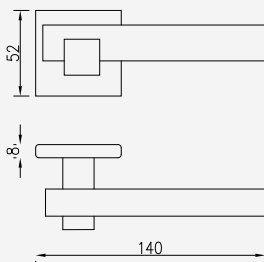

TUBULAR LEVER HANDLES

DOOR HARDWARE

PRODUCT CODE

LIL022

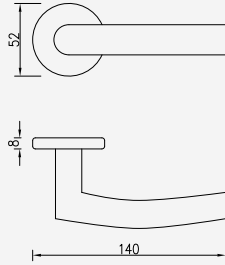

PRODUCT CODE

LIL023

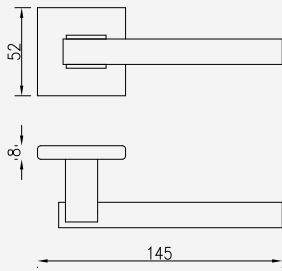

**PRODUCT CODE**

LIL101

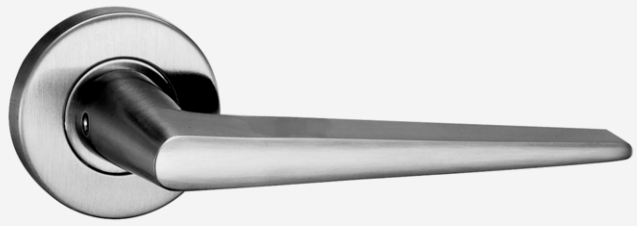
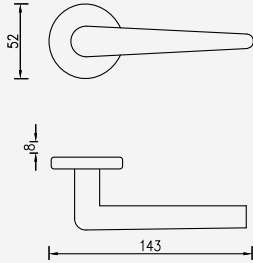

**PRODUCT CODE**

LIL102

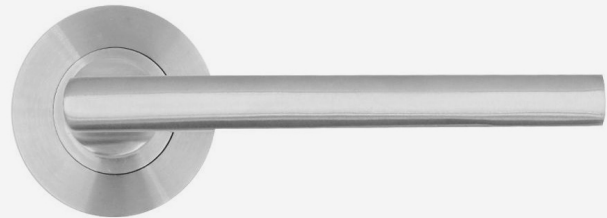
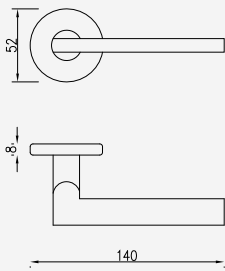

**PRODUCT CODE**

LIL103

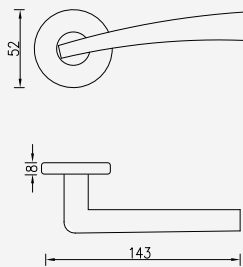

**SOLID LEVER HANDLES**

DOOR HARDWARE

**PRODUCT CODE**

LIL104

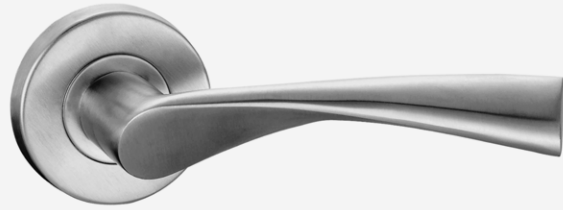
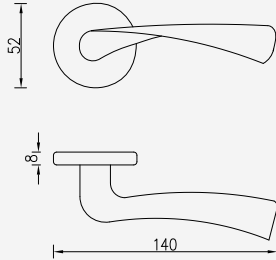

**PRODUCT CODE**

LIL105

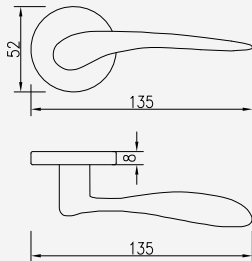

**PRODUCT CODE**

LIL106

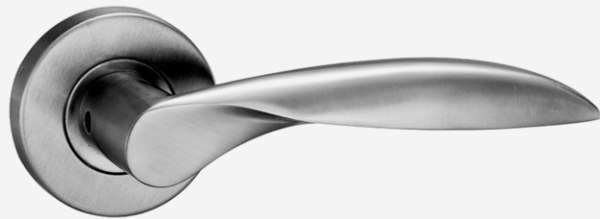
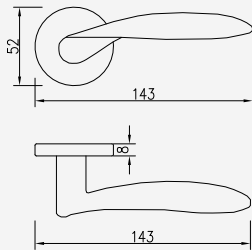

**PRODUCT CODE**

LIL107

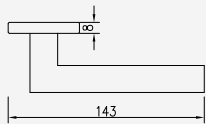
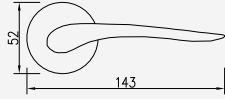

**PRODUCT CODE**

LIL108

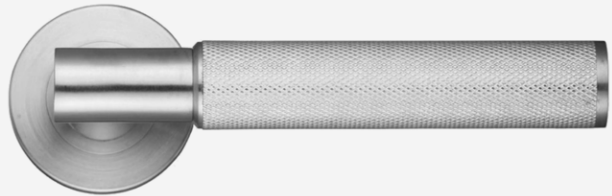
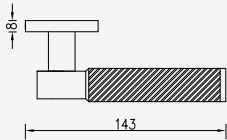
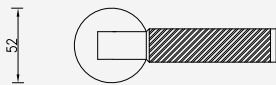

**PRODUCT CODE**

LIL109

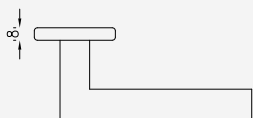
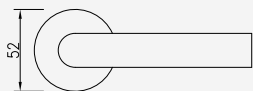

**SOLID LEVER HANDLES**

DOOR HARDWARE

**PRODUCT CODE**

LIL110

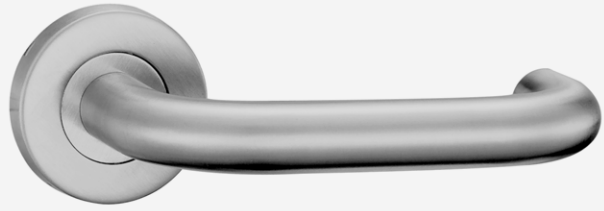
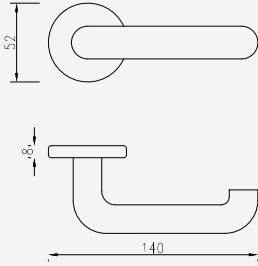

**PRODUCT CODE**

LIL111

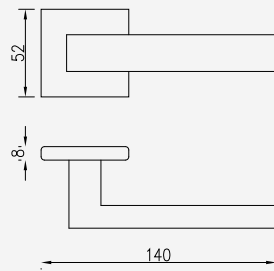

**PRODUCT CODE**

LIL112

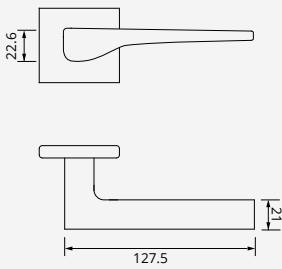

**PRODUCT CODE**

LIL113

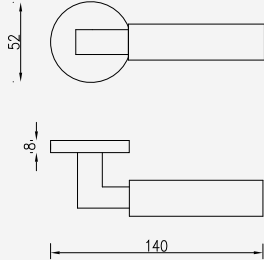

**PRODUCT CODE**

LIL114

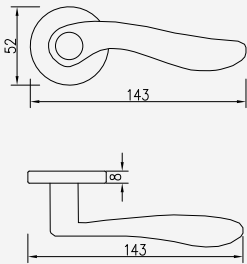

**PRODUCT CODE**

LIL115

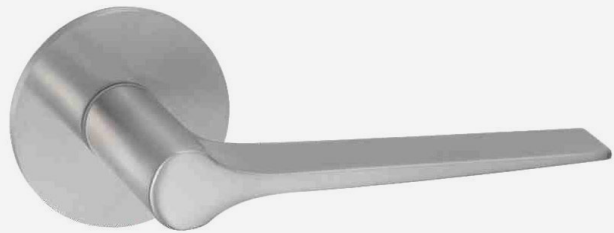
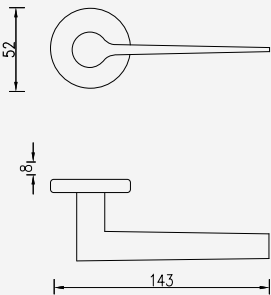

**SOLID LEVER HANDLES**

DOOR HARDWARE

**PRODUCT CODE**

LIL116

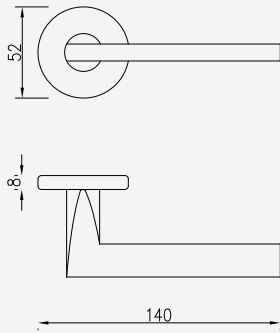

**PRODUCT CODE**

LIL117

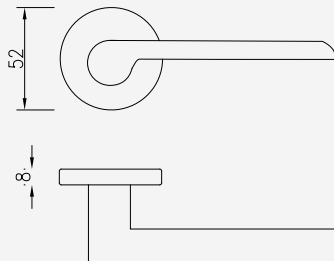

**PRODUCT CODE**

LIL118

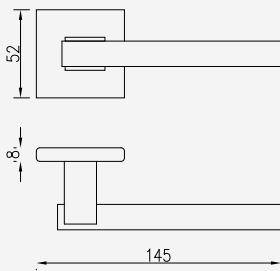

**PRODUCT CODE**

LIL119

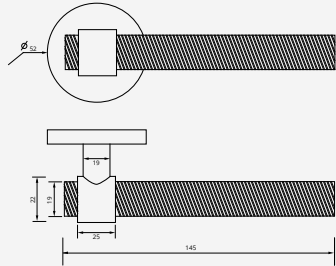

**PRODUCT CODE**

LIL120

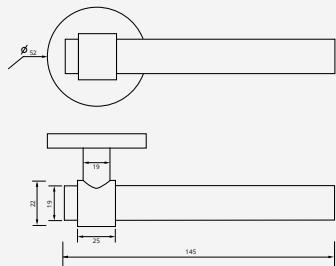

LEVER HANDLES

DOOR HARDWARE

PRODUCT CODE

LIL201

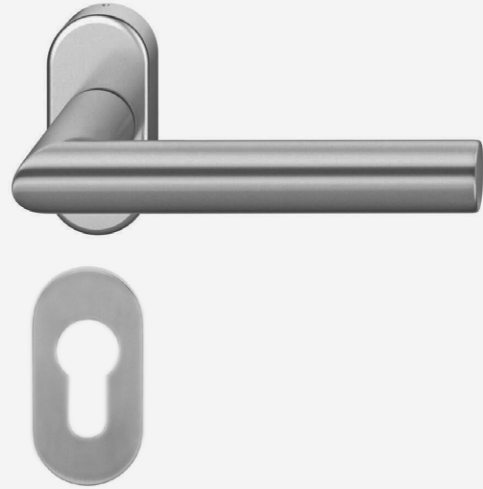
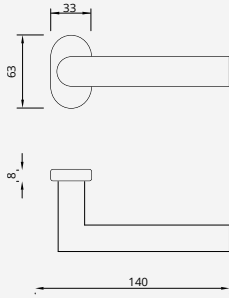

PRODUCT CODE

LIL202

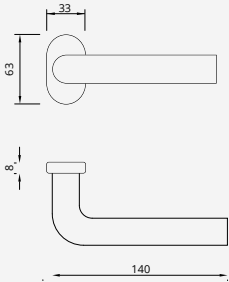

PRODUCT CODE

LIL203

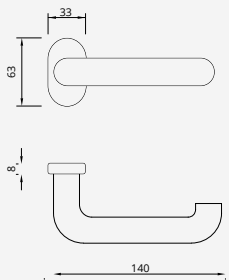

**PRODUCT CODE**

LILA01

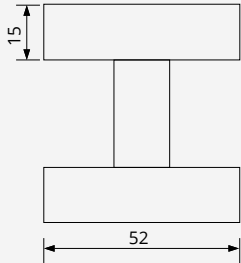

**PRODUCT CODE**

LILA02

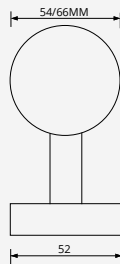

**PRODUCT CODE**

LILA03

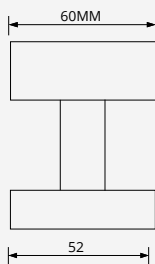

## LEVER HANDLES

Tubular construction sprung lever handle on 170x170mm square backplate

### PRODUCT CODE

Length	Thickness	Handing	Finish	Cut out
LIL208	2mm	N	SSS	EPC
LIL209	2mm	N	PSS	EPC
LIL210	3mm	N	SSS	EPC
LIL211	3mm	N	PSS	EPC
LIL212L	2mm	L	SSS	WC
LIL212R	2mm	R	SSS	WC
LIL213L	2mm	L	PSS	WC
LIL213R	2mm	R	PSS	WC
LIL214L	3mm	L	SSS	WC
LIL214R	3mm	R	SSS	WC
LIL215L	3mm	L	PSS	WC
LIL215R	32mm	R	PSS	WC

**N**-Non Handed; **L**-Left Handed; **R**-Right Handed  
**EPC**-Euro profile cylinder  
**WC**- WC indicator

### SPECIFICATION

22mm dia spring assisted stainless steel SS304 grade tubular lever handle on 170x170mm square back plate  
 With 72mm CTC for EPC cut-out and 78mm CTC for WC indicator  
 Available in 2mm and 3mm thickness backplate 8mm x 8mm square spindle  
 Non-handed design for EPC cut-out  
 Handed design for WC indicator  
 Suitable for use on fire/smoke door assemblies  
 Supplied with suitable screws and fixings

### FINISHES

SSS	Satin stainless steel
PSS	Polished stainless steel

\*SS316 available upon request subject to minimum order quantity

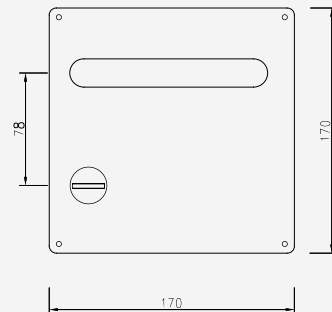
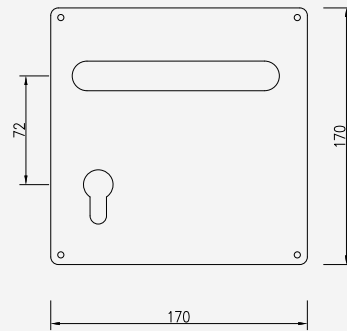

# PULL HANDLES

Lockron Pull handle series consists of several profiles made exclusively from 304 grade stainless steel with various fixing options.

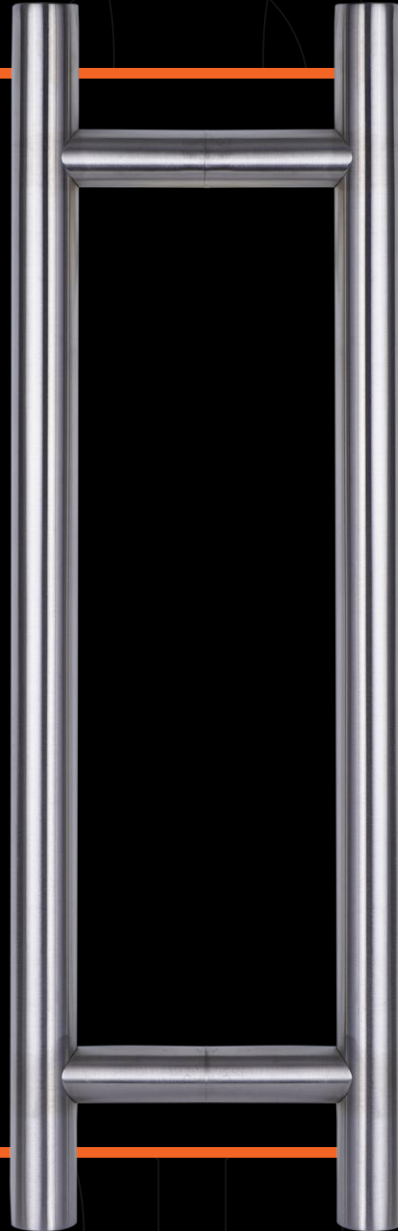

## Available Fixings

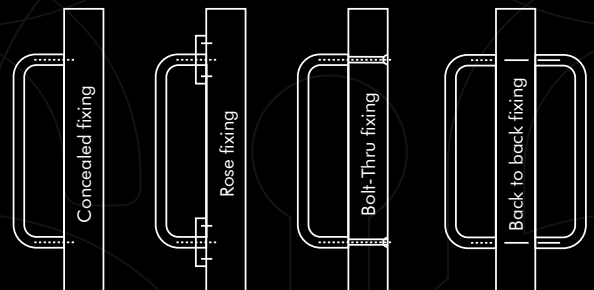

Featured Product

**LIPH450B**

## PULL HANDLES

### FEATURES

- Manufactured from highest grade Stainless Steel SS304
- Heavy duty inserts for long lasting durability
- Adheres to the guidelines of BS 8300
- One package suitable for Wood, Metal, Glass and Aluminum doors Supplied with suitable screws and fixings

### AVAILABLE FIXINGS

- Back to back fixing
- Bolt Thru fixing
- Concealed fixing
- Rose Fixing

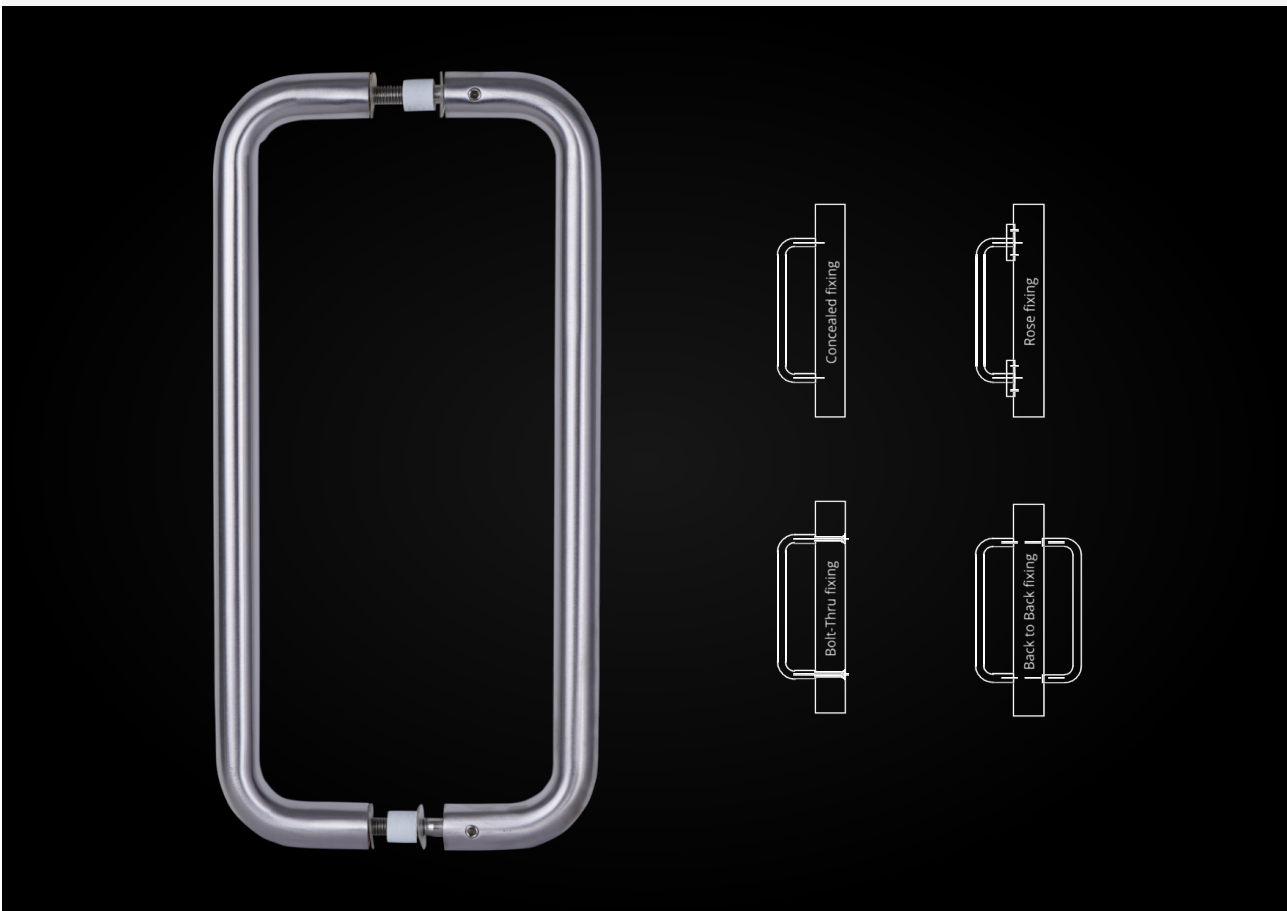

### FINISHES

SSS	Satin stainless steel
PSS	Polished stainless steel
PVDB	PVD Black
PVDG	PVD Gold

\*Special finish available upon request  
\*SS316 available upon request

**PRODUCT CODE**

Code	Length	Diameter
LIPD150A	150mm	19mm
LIPD225A	225mm	19mm
LIPD300A	300mm	19mm
LIPD300B	300mm	22mm
LIPD300E	300mm	25mm
LIPD300C	300mm	32mm
LIPD425B	425mm	22mm
LIPD425E	425mm	25mm
LIPD425C	425mm	32mm
LIPD600B	600mm	22mm
LIPD600E	600mm	25mm
LIPD600C	600mm	32mm

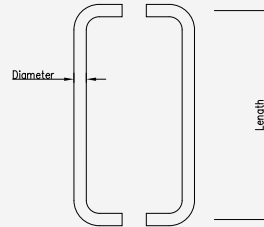

**PRODUCT CODE**

Code	Length	CTC	Diameter
LIPH350B	350mm	250mm	22mm
LIPH450B	450mm	350mm	22mm
LIPH450C	450mm	350mm	32mm
LIPH525B	525mm	425mm	22mm
LIPH700C	700mm	600mm	32mm
LIPH800C	800mm	700mm	32mm
LIPH1000C	1000mm	850mm	32mm
LIPH1500D	1500mm	1300mm	38mm
LIPH2000D	2000mm	1800mm	38mm

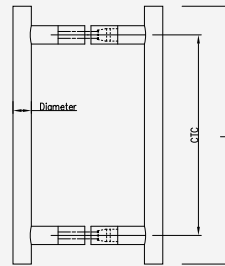

**PRODUCT CODE**

Code	Length	CTC	Square
LIPHSQ450E	450mm	300mm	25mm
LIPHSQ600E	600mm	450mm	25mm
LIPHSQ775E	775mm	600mm	25mm
LIPHSQ1000E	1000mm	800mm	25mm
LIPHSQ1200E	1200mm	1000mm	25mm
LIPHSQ1600E	1600mm	1400mm	25mm
LIPHSQ1800E	1800mm	1600mm	25mm

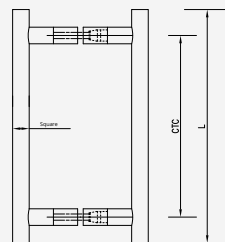

**PULL HANDLES**

DOOR HARDWARE

**PRODUCT CODE**

Code	Length	Square
LIPMSQ225F	225mm	20mm
LIPMSQ300F	300mm	20mm
LIPMSQ450F	450mm	20mm
LIPMSQ600F	600mm	20mm
LIPMSQ225E	225mm	25mm
LIPMSQ300E	300mm	25mm
LIPMSQ450E	450mm	25mm
LIPMSQ600E	600mm	25mm

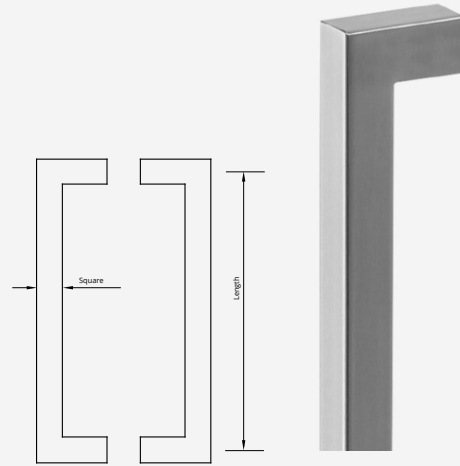

**PRODUCT CODE**

Code	Length	Thickness	Width
LIPMR450X	450mm	15mm	30mm
LIPMR600X	600mm	15mm	30mm
LIPMR800X	800mm	15mm	30mm
LIPMR450Y	450mm	20mm	40mm
LIPMR600Y	600mm	20mm	40mm
LIPMR800Y	800mm	20mm	40mm

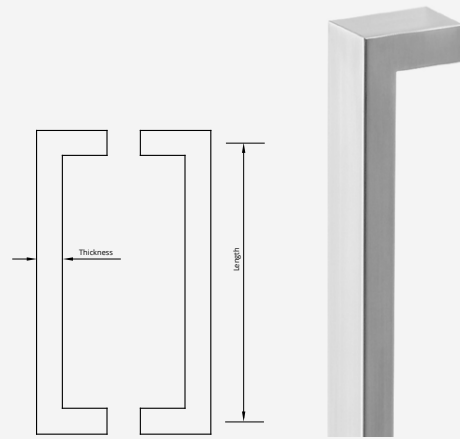

**PRODUCT CODE**

Code	Length	Square
LIOPMSQ300E	300mm	25mm
LIOPMSQ450E	450mm	25mm
LIOPMSQ600E	600mm	25mm

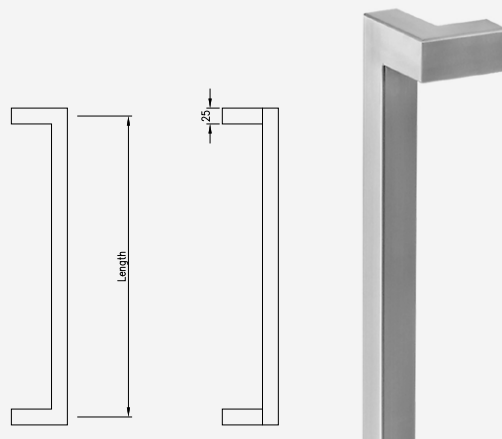

**PRODUCT CODE**

Code	Length	Diameter
LIOPD300E	300mm	25mm
LIOPD450E	450mm	25mm
LIOPD450C	450mm	32mm
LIOPD600C	600mm	32mm
LIOPD800C	8 00mm	32mm

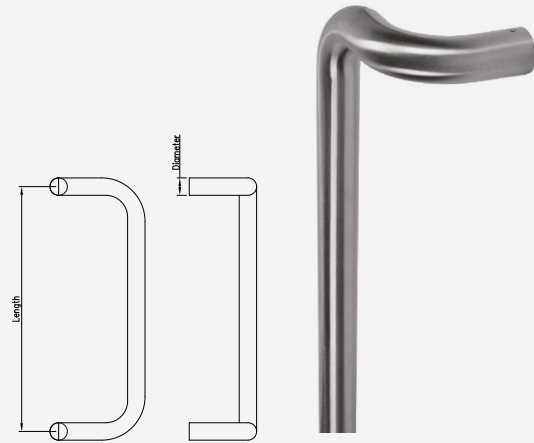

**PRODUCT CODE**

Code	Length	Diameter
LIPM300A	300mm	19mm
LIPM425B	425mm	22mm

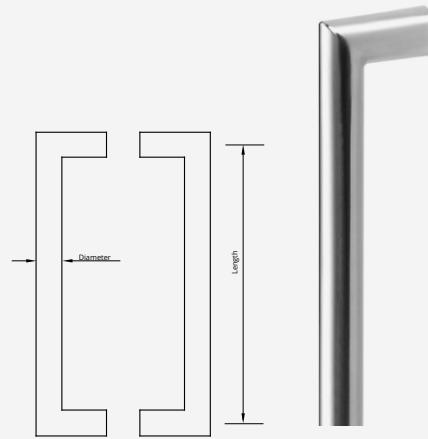

**PRODUCT CODE**

Code	Length	Square
LIPHT600B	600mm	22mm
LIPHT600F	600mm	20mm

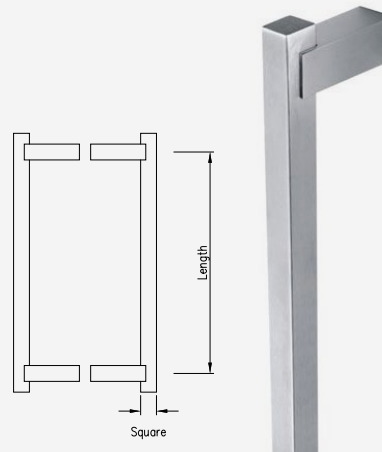

**PULL HANDLES**

DOOR HARDWARE

**PRODUCT CODE - How to order**

- LIPD \_\_\_ 300A (300 CTC, 19mm dia)
- BS 225A (225 CTC, 19mm dia)
- CS 300B (300 CTC, 22mm dia)
- RS 300E (300 CTC, 25mm dia)
- 450C (450 CTC, 32mm dia)
- 600E (600 CTC, 25mm dia)
- 600C (600 CTC, 32mm dia)
- 800C (800 CTC, 32mm dia)

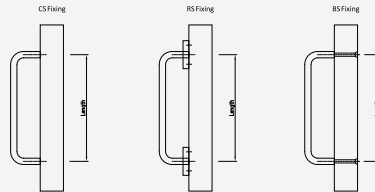

**PRODUCT CODE - How to order**

- LIPH \_\_\_ 300A (300 CTC, 400 L, 19mm dia)
- BS 300B (300 CTC, 400 L, 22mm dia)
- CS 350C (350 CTC, 450 L, 32mm dia)
- RS 600B (600 CTC, 700 L, 22mm dia)
- 600C (600 CTC, 700 L, 32mm dia)

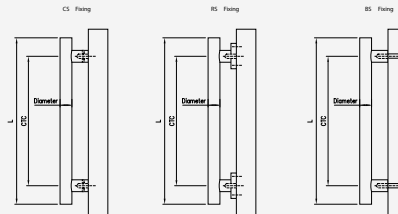

## LOCKABLE PULL HANDLE

H-type lockable pull handle with back to back fixing

### PRODUCT CODE

LIPL1500

### APPLICATION

For internal and external glass door assemblies

### DIMENSION

Diameter 35mm  
CTC 1125mm  
Overall length 1500mm

### SPECIFICATION

H-type lockable pull handle with back to back fixing with one side key and one side thumb turn  
Heavy duty inserts for long lasting durability  
Manufactured from Stainless steel SS304 grade To suit glass thickness of 10mm - 12mm  
Suitable for glass door applications  
Supplied with suitable screws and fixings

### QUALITY AND PERFORMANCE

Successfully inhouse type tested for conformity to all the requirements of BS EN1154

### FINISHES

SSS	Satin Stainless Steel
PSS	Polished Stainless Steel
BLK	Black

\*Special finish available upon request subject to minimum order quantity

\*Custom sizes available upon request subject to minimum order quantity

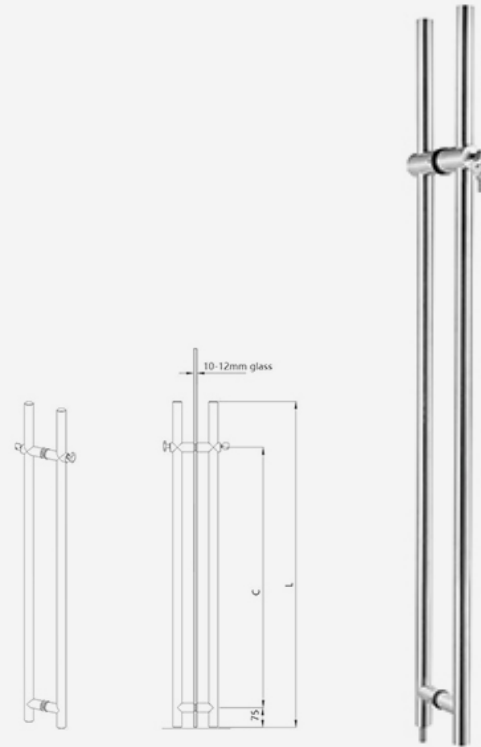

For flush doors

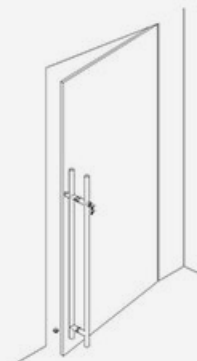

For sliding doors

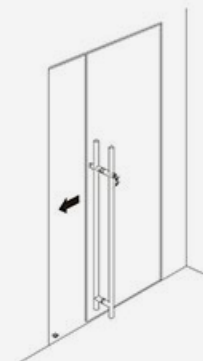

# LOCKS AND LATCHES

Lockron Mortise locks range contains products which have been tested in compliance to BS EN 12209 Grade 3, CE Marked.



Featured Product

**LIM421**

Available Forends



## LOCKS AND LATCHES

Mortise Sash Lock with 72mm CTC with closed case prepared for euro profile cylinders and standard fittings

### PRODUCT CODE

LIM421

### BACKSETS AVAILABLE

55/60/65mm

Standard 55mm

### SPECIFICATION

Mortise sash lock with reversible Latch and 20mm projecting double throw Deadbolt, conforming to BS EN 12209, CE marked

8mm grip tight square follower

Stainless steel SS304 grade latch bolt & dead bolt

SS304 grade strike plate with dust box

22mm SS304 grade forend available in square and round corners

Supplied with suitable screws and fixings

### QUALITY AND PERFORMANCE

Successfully type tested for conformity to all the requirements of BS EN12209:2003/AC:2005

3 X 9 1 0 G 3 B C 2 0

### FINISHES

SSS	Satin stainless steel
PSS	Polished stainless steel
PVDB	PVD Black
PVDG	PVD Gold

\*Special finish available upon request subject to minimum order quantity

\*SS316 available upon request subject to minimum order quantity

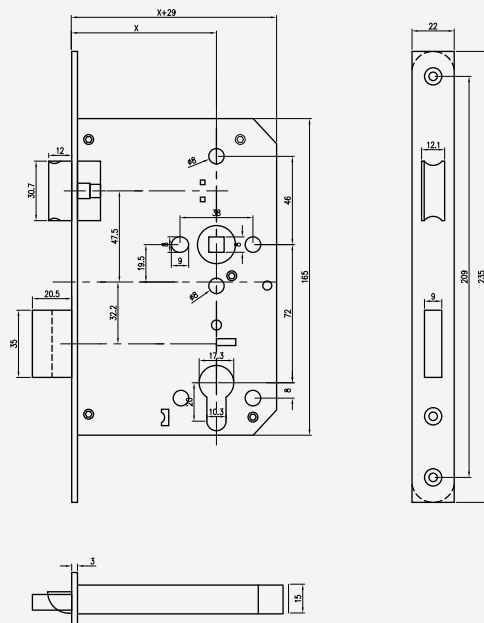
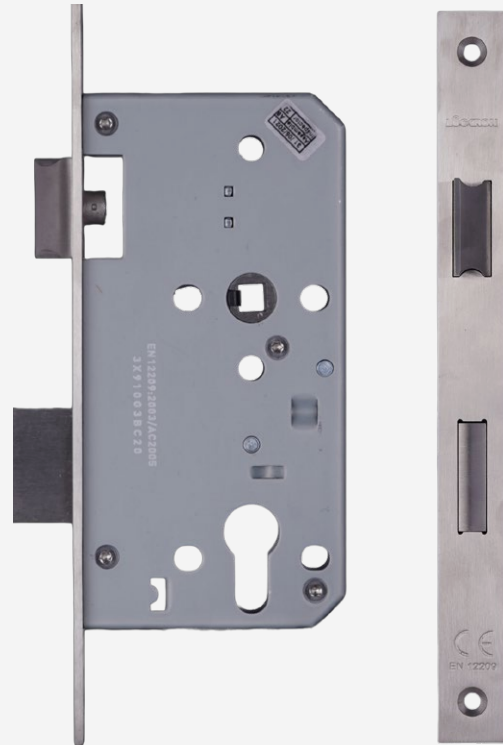

## LOCKS AND LATCHES

Mortise Bathroom Lock with 78mm CTC with closed case prepared for 8mm square follower and standard fittings

### PRODUCT CODE

LIM422

### BACKSETS AVAILABLE

55/60/65mm  
Standard 55mm

### SPECIFICATION

Mortise Bathroom lock with reversible Latch and 20mm projecting double throw Deadbolt, conforming to BS EN 12209, CE marked  
8mm grip tight square follower  
Stainless steel SS304 grade latch bolt & dead bolt  
SS304 grade strike plate with dust box  
22mm SS304 grade forend available in square and round corners  
Supplied with suitable screws and fixings

### QUALITY AND PERFORMANCE

Successfully type tested for conformity to all the requirements of BS EN12209:2003/AC:2005

3 X 9 1 0 G - B 0 2 0

### FINISHES

SSS	Satin stainless steel
PSS	Polished stainless steel
PVDB	PVD Black
PVDG	PVD Gold

\*Special finish available upon request subject to minimum order quantity  
\*SS316 available upon request subject to minimum order quantity

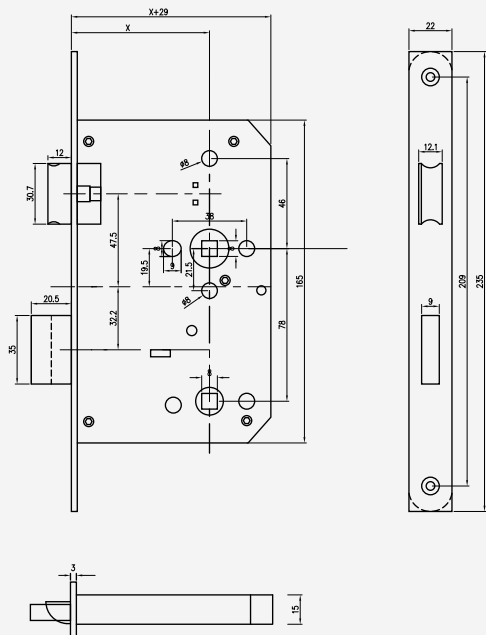

## LOCKS AND LATCHES

Mortise Dead Lock with 72mm CTC with closed case prepared for euro profile cylinders and standard fittings

### PRODUCT CODE

LIM423

### BACKSETS AVAILABLE

55/60/65mm

Standard 55mm

### SPECIFICATION

Mortise dead lock with 20mm projecting double throw Deadbolt, conforming to BS EN 12209, CE marked  
Prepared for euro profile cylinders  
Stainless steel SS304 grade dead bolt  
SS304 grade strike plate with dust box  
22mm SS304 grade forend available in square and round corners  
Supplied with suitable screws and fixings

### QUALITY AND PERFORMANCE

Successfully type tested for conformity to all the requirements of BS EN12209:2003/AC:2005

3 X 9 1 0 G 3 B C 0 0

### FINISHES

SSS	Satin stainless steel
PSS	Polished stainless steel
PVDB	PVD Black
PVDG	PVD Gold

\*Special finish available upon request subject to minimum order quantity  
\*SS316 available upon request subject to minimum order quantity

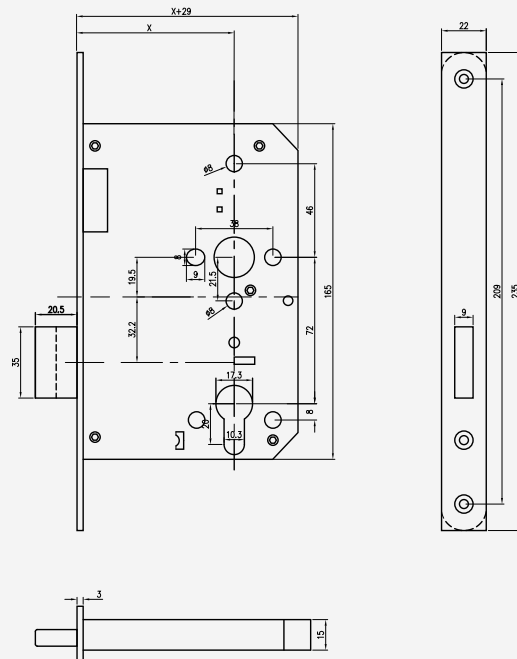

## LOCKS AND LATCHES

Mortise Latch Lock with 72mm CTC with closed case prepared for euro profile cylinders and standard fittings

### PRODUCT CODE

LIM424

### BACKSETS AVAILABLE

55/60/65mm  
Standard 55mm

### SPECIFICATION

Mortise latch lock with reversible Latch, conforming to BS EN 12209, CE marked Prepared for euro profile cylinders Stainless steel SS304 grade latch bolt 8mm grip tight square follower SS304 grade strike plate with dust box 22mm SS304 grade forend available in square and round corners Supplied with suitable screws and fixings

### QUALITY AND PERFORMANCE

Successfully type tested for conformity to all the requirements of BS EN12209:2003/AC:2005

3 X 9 1 0 G - B 0 2 0

### FINISHES

SSS	Satin stainless steel
PSS	Polished stainless steel
PVDB	PVD Black
PVDG	PVD Gold

\*Special finish available upon request subject to minimum order quantity  
\*SS316 available upon request subject to minimum order quantity

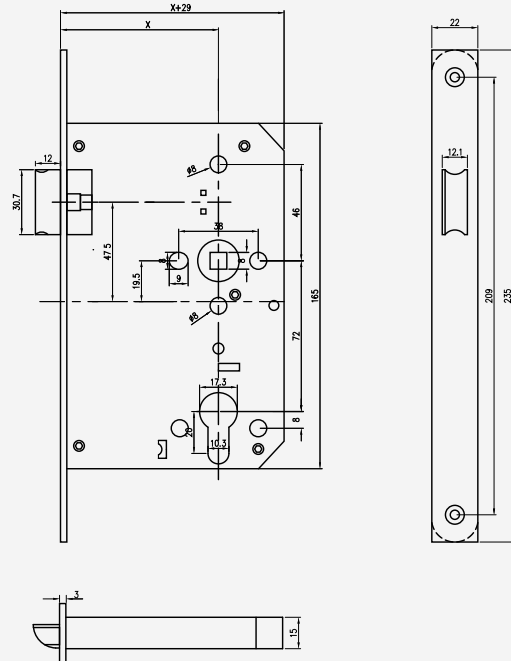

## LOCKS AND LATCHES

Mortise Roller Sash Lock with 72mm CTC with closed case prepared for euro profile cylinders and standard fittings

### PRODUCT CODE

LIM425

### BACKSETS AVAILABLE

55/60/65mm  
Standard 55mm

### SPECIFICATION

Mortise roller sash lock with roller Latch and 20mm projecting double throw Deadbolt, Manufactured according to BS EN 12209  
Suitable for double action doors  
Stainless steel SS304 grade roller latch & dead bolt  
SS304 grade strike plate with dust box  
22mm SS304 grade forend available in square and round corners  
Supplied with suitable screws and fixings

### QUALITY AND PERFORMANCE

Successfully inhouse type tested for conformity to all the requirements of BS EN12209:2003

### FINISHES

SSS	Satin stainless steel
PSS	Polished stainless steel
PVDB	PVD Black
PVDG	PVD Gold

\*Special finish available upon request subject to minimum order quantity

\*SS316 available upon request subject to minimum order quantity

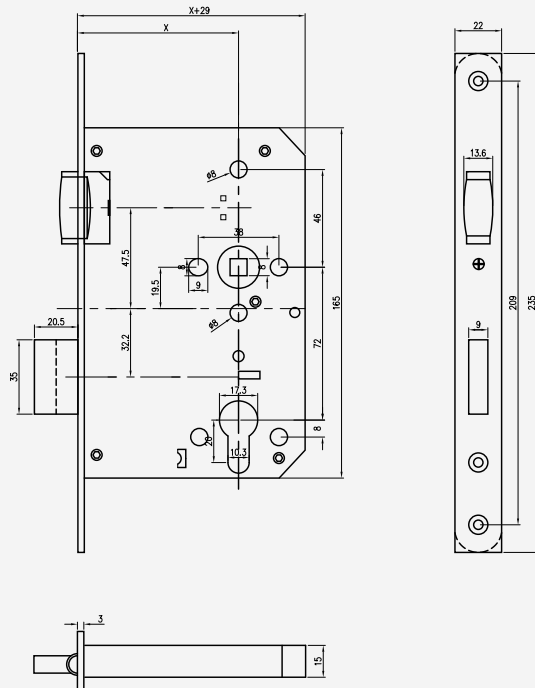

## LOCKS AND LATCHES

Mortise Night Latch Lock with 72mm CTC with closed case prepared for euro profile cylinders and standard fittings

### PRODUCT CODE

LIM426

### BACKSETS AVAILABLE

55/60/65mm  
Standard 55mm

### SPECIFICATION

Mortise Night latch lock with reversible Latch, conforming to BS EN 12209, CE marked Prepared for euro profile cylinders  
Stainless steel SS304 grade latch bolt  
8mm grip tight square follower  
SS304 grade strike plate with dust box  
22mm SS304 grade forend available in square and round corners  
Supplied with suitable screws and fixings

### QUALITY AND PERFORMANCE

Successfully type tested for conformity to all the requirements of BS EN12209:2003/AC:2005

3 X 9 1 0 G 2 B B 2 0

### FINISHES

SSS	Satin stainless steel
PSS	Polished stainless steel
PVDB	PVD Black
PVDG	PVD Gold

\*Special finish available upon request subject to minimum order quantity  
\*SS316 available upon request subject to minimum order quantity

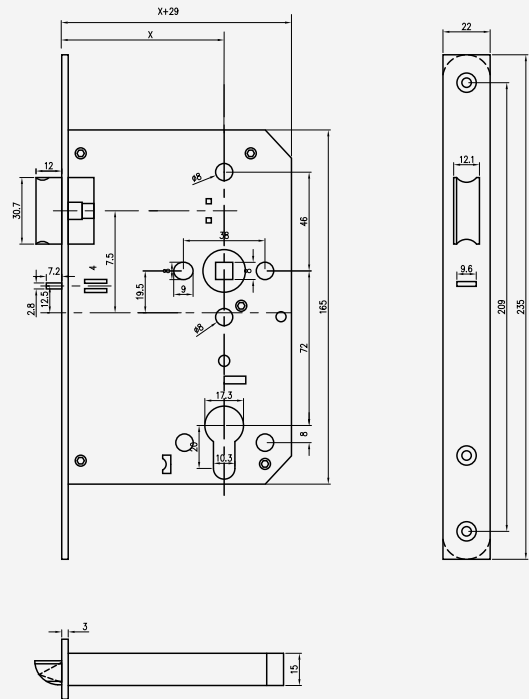

## LOCKS AND LATCHES

Mortise Classroom Lock with 72mm CTC with closed case prepared for euro profile cylinders and standard fittings

### PRODUCT CODE

LIM427

### BACKSETS AVAILABLE

55/60/65mm  
Standard 55mm

### SPECIFICATION

Mortise Classroom lock with reversible Latch  
Prepared for euro profile cylinders  
Manufactured according to BS EN 12209  
Stainless steel SS304 grade latch bolt  
8mm grip tight square follower  
SS304 grade strike plate with dust box  
22mm SS304 grade forend available in square and round corners  
Supplied with suitable screws and fixings

### QUALITY AND PERFORMANCE

Successfully inhouse type tested for conformity to all the requirements of BS EN12209:2003

### FINISHES

SSS	Satin stainless steel
PSS	Polished stainless steel
PVDB	PVD Black
PVDG	PVD Gold

\*Special finish available upon request subject to minimum order quantity

\*SS316 available upon request subject to minimum order quantity

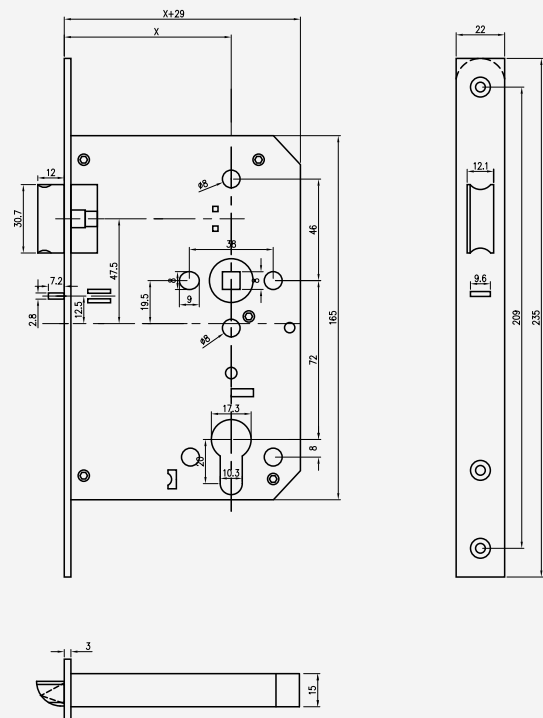

## LOCKS AND LATCHES

Mortise Escape Lock with 72mm CTC with closed case prepared for euro profile cylinders and standard fittings

### PRODUCT CODE

LIM428

### BACKSETS AVAILABLE

55/60/65mm  
Standard 55mm

### SPECIFICATION

Mortise escape lock with reversible Latch and 20mm projecting single throw Deadbolt  
Free egress always from inside retracting both latch and deadbolt in one action  
8mm grip tight square follower  
Stainless steel SS304 grade latch bolt & dead bolt  
SS304 grade strike plate with dust box  
22mm SS304 grade forend available in square and round corners  
Including 8mm square split spindle  
Supplied with suitable screws and fixings

### QUALITY AND PERFORMANCE

Successfully inhouse type tested for conformity to all the requirements of BS EN12209 and BS EN179

### FINISHES

SSS	Satin stainless steel
PSS	Polished stainless steel
PVDB	PVD Black
PVDG	PVD Gold

\*Special finish available upon request subject to minimum order quantity  
\*SS316 available upon request subject to minimum order quantity

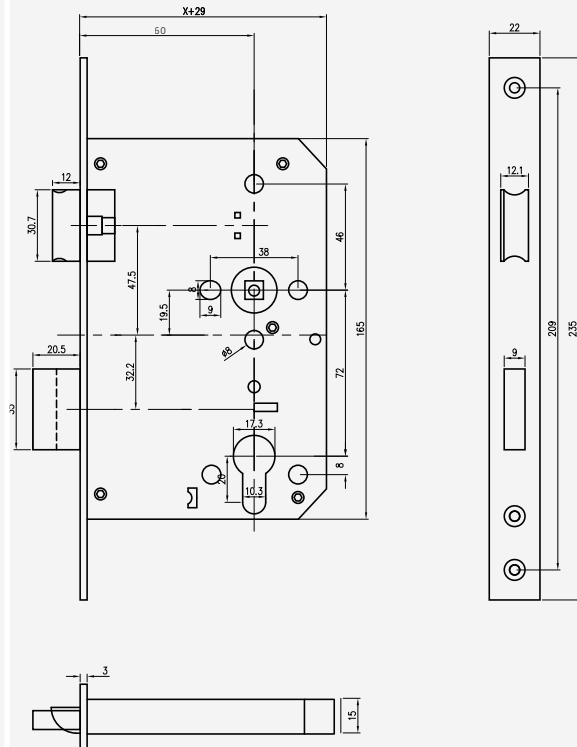

## LOCKS AND LATCHES

Mortise Sash lock with automatic dead bolt function with 72mm CTC with closed case prepared for euro profile cylinders and standard fittings

### PRODUCT CODE

LIM429

### BACKSETS AVAILABLE

Standard 55mm

### SPECIFICATION

Mortise lock with twin Latch – Non handed, can be used on LH or RH door without changing latch direction and 20mm projecting single throw Deadbolt.  
Automatic dead lock function – Dead bolt projects automatically when door closes  
8mm square follower with 8mm square split spindle  
Stainless steel SS304 grade latch bolt & dead bolt SS304 grade strike plate with dust box  
20/22mm SS304 grade forend available in square and round corners  
Supplied with suitable screws and fixings

### OPERATION

**Inside**-Lever operates dead bolt giving free egress

**Outside**-Dead bolt operated by cylinder

**Latch**-Twin latch retracts automatically when door opens and closes. Latch becomes rigid when dead bolt is projected

### QUALITY AND PERFORMANCE

Successfully inhouse type tested for conformity to all the requirements of BS EN12209:2003

### FINISHES

SSS	Satin stainless steel
PSS	Polished stainless steel
PVDB	PVD Black
PVDG	PVD Gold

\*Special finish available upon request subject to minimum order quantity

\*SS316 available upon request subject to minimum order quantity

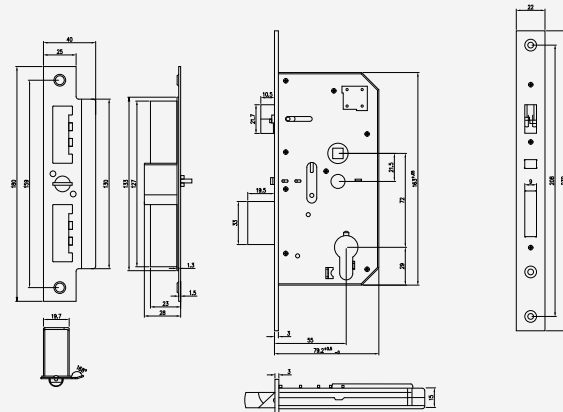

## LOCKS AND LATCHES

Mortise small case Lock with 55 mm Backset with closed case prepared for euro profile cylinders/8mm follower and standard fittings

### PRODUCT CODE

- LIM443 - Small case Deadlock
- LIM444 - Small case Latch lock
- LIM445 - Small case Deadlock with 8mm follower

### BACKSETS AVAILABLE

Standard 55mm

#### LIM443

Mortise small case dead lock with deadbolt prepared for euro profile cylinders

#### LIM444

Mortise small case latch lock with reversible Latch prepared for euro profile cylinders

#### LIM445

Mortise small case dead lock with deadbolt prepared for 8mm square grip tight follower

### SPECIFICATION

- Stainless steel SS304 grade latch bolt/ dead bolt
- SS304 grade strike plate with dust box
- 22mm SS304 grade forend available in square and round corners
- Supplied with suitable screws and fixings

### FINISHES

SSS	Satin stainless steel
PSS	Polished stainless steel
PVDB	PVD Black
PVDG	PVD Gold

\*Special finish available upon request subject to minimum order quantity

\*SS316 available upon request subject to minimum order quantity

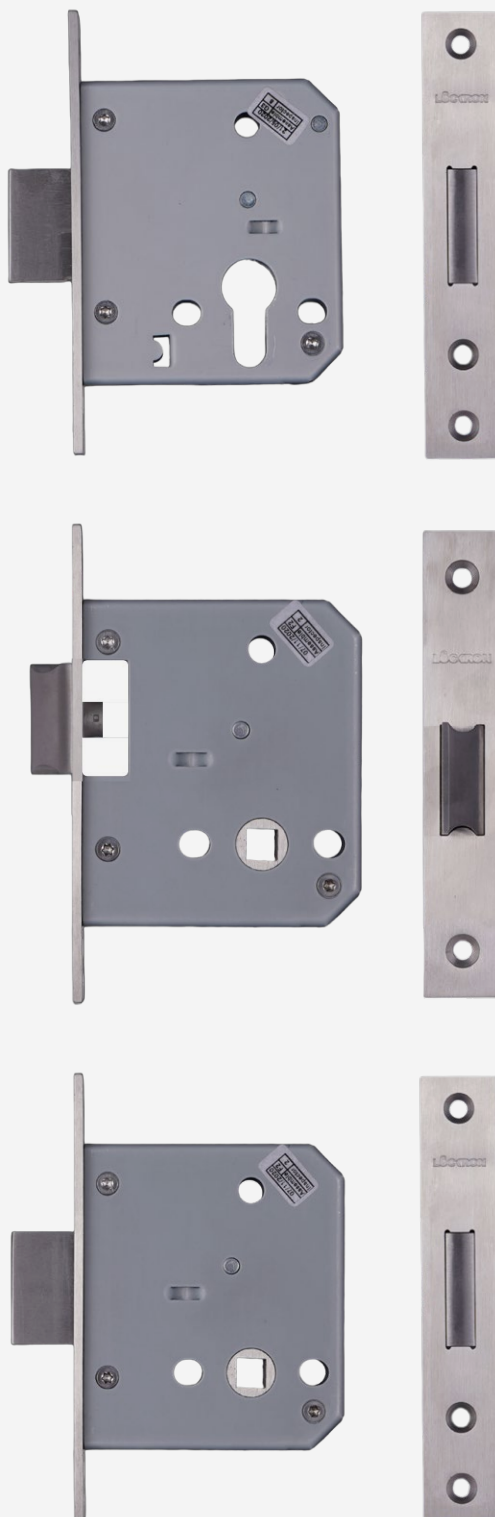
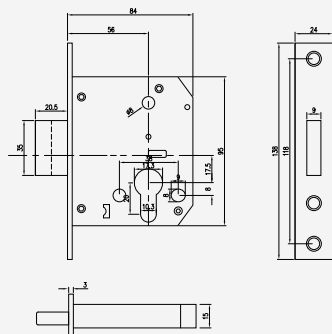

## LOCKS AND LATCHES

Mortise small case hook lock for sliding doors with 50mm backset with closed case prepared for euro profile cylinders/8mm square follower and standard fittings

### PRODUCT CODE

LIM451 - Prepared for euro profile cylinders  
LIM452 - Prepared for 8mm square follower

### BACKSETS AVAILABLE

50mm

### LIM451

Mortise small case hook lock for sliding doors prepared for euro profile cylinders

### LIM452

Mortise small case hook lock for sliding doors Prepared for 8mm square follower

### SPECIFICATION

Stainless steel SS304 grade hook bolt  
SS304 grade strike plate with dust box  
16mm wide SS304 grade forend with round corners  
Non-handed design  
Supplied with suitable screws and fixings

### FINISHES

SSS	Satin stainless steel
PSS	Polished stainless steel
PVDB	PVD Black
PVDG	PVD Gold

\*Special finish available upon request subject to minimum order quantity

\*SS316 available upon request subject to minimum order quantity



LIM452

LIM451

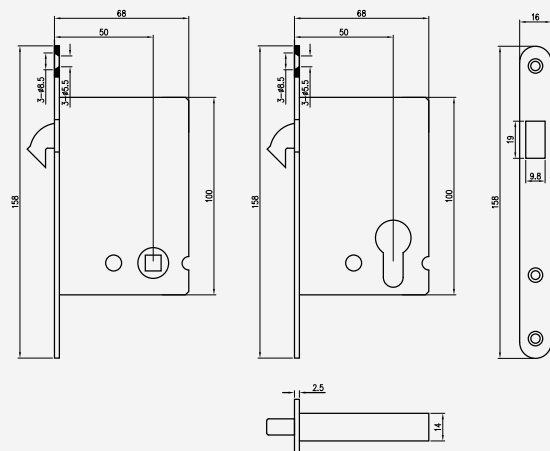

## LOCKS AND LATCHES

Mortise small case hook Lock for sliding doors with 50mm Backset with closed case prepared for 8mm follower and standard fittings

### PRODUCT CODE

LIM453

### BACKSETS AVAILABLE

Standard 50mm

### SPECIFICATION

Mortise small case hook lock prepared for 8mm square follower  
 Stainless steel SS304 grade hook bolt  
 SS304 grade strike plate with dust box  
 16mm wide SS304 grade forend with round corners  
 Non-handed design supplied with door edge pull for pocket sliding doors  
 Supplied with suitable screws and fixings

### OPTIONS AVAILABLE

- Kit 1 - 127mm x 45mm x 8mm
- Kit 2 - 127mm x 45mm x 8mm
- Kit 3 - Dia 52mm x 10mm
- Kit 4 - 60mm x 60mm x 10mm

### FINISHES

SSS	Satin stainless steel
PSS	Polished stainless steel
PVDB	PVD Black
PVDG	PVD Gold

\*Special finish available upon request subject to minimum order quantity

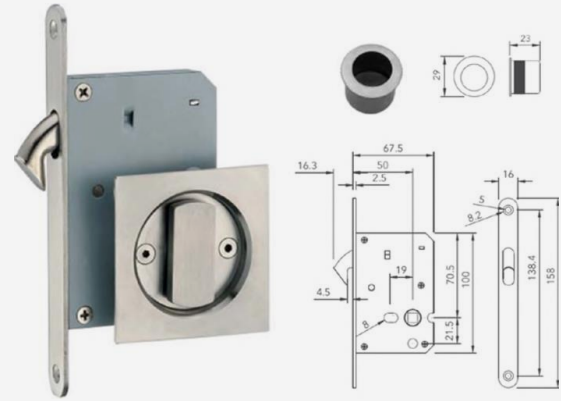

Kit 1

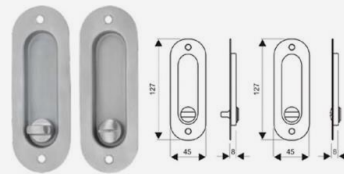

Kit 2

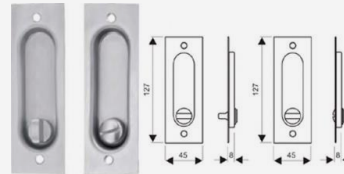

Kit 3

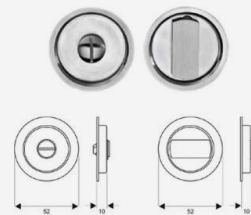

Kit 4

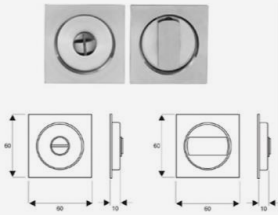

## LOCKS AND LATCHES

Mortise magnetic Sash Lock with 72mm CTC with closed case prepared for euro profile cylinders and standard fittings

### PRODUCT CODE

LIM421M

### BACKSETS AVAILABLE

55/60/65mm – Standard 55mm

### SPECIFICATION

Mortise sash lock with magnetic Latch and 20mm projecting double throw Deadbolt  
8mm grip tight square follower  
Stainless steel SS304 grade dead bolt  
SS304 grade strike plate with dust box  
22mm SS304 grade forend available in square and round corners  
Supplied with suitable screws and fixings

### QUALITY AND PERFORMANCE

Successfully inhouse type tested for conformity to all the requirements of BS EN12209:2003/AC:2005

### FINISHES

SSS	Satin stainless steel
PSS	Polished stainless steel
PVDB	PVD Black
PVDG	PVD Gold

\*Special finish available upon request subject to minimum order quantity

\*SS316 available upon request subject to minimum order quantity

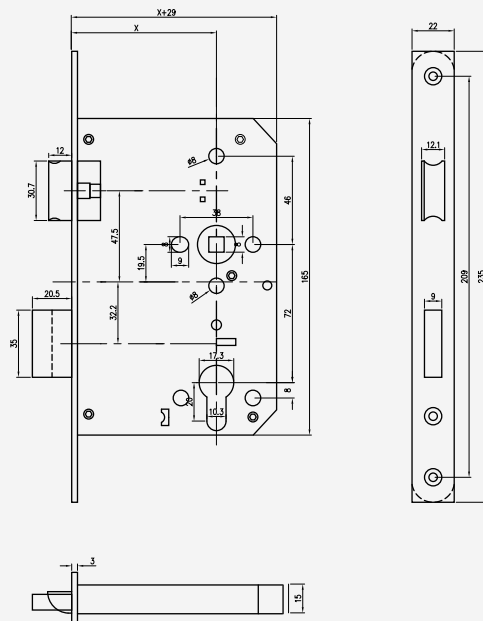

## LOCKS AND LATCHES

Mortise Sash Lock with 85mm CTC with closed case prepared for euro profile cylinders and standard fittings

### PRODUCT CODE

LIM4585

### BACKSETS AVAILABLE

45mm

### SPECIFICATION

Mortise sash lock with reversible Latch and 20mm projecting double throw Deadbolt  
8mm grip tight square follower  
Zinc alloy latch bolt & dead bolt  
Stainless Steel strike plate with dust box  
22mm Stainless Steel forend available in square corners  
Supplied with suitable screws and fixings

### QUALITY AND PERFORMANCE

Successfully inhouse type tested for conformity to all the requirements of BS EN12209

### FINISHES

SSS	Satin stainless steel
PSS	Polished stainless steel
PVDB	PVD Black
PVDG	PVD Gold

\*Special finish available upon request subject to minimum order quantity

\*SS316 available upon request subject to minimum order quantity

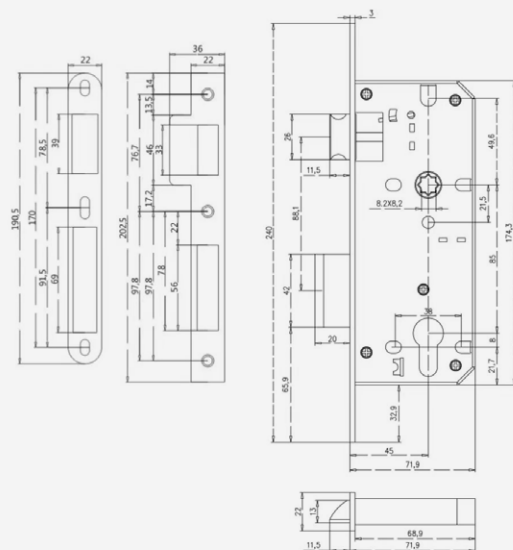

## LOCKS AND LATCHES

Mortise Narrow Sash Lock with 92mm CTC with closed case prepared for euro profile cylinders and standard fittings

### PRODUCT CODE

LIM431

### BACKSETS AVAILABLE

30/35mm

### SPECIFICATION

Mortise narrow sash lock with reversible Latch and 15 mm projecting double throw Deadbolt, BS EN12209 inhouse performance teste d 8mm grip tight square follower Stainless steel strike plate with dust box 24mm forend available in square corners Supplied with suitable screws and fixings

### QUALITY AND PERFORMANCE

Successfully inhouse type tested for conformity to all the requirements of BS EN12209:2003 /AC:2005

### FINISHES

SSS	Satin stainless steel
PSS	Polished stainless steel
PVDB	PVD Black
PVDG	PVD Gold

\*Special finish available upon request subject to minimum order quantity

\*SS316 available upon request subject to minimum order quantity

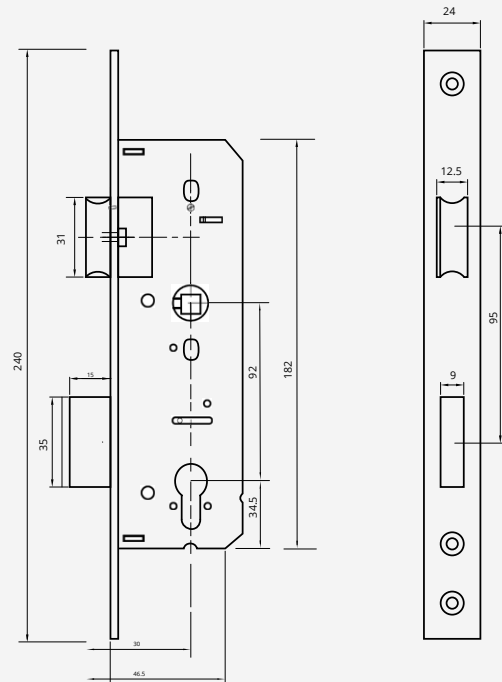

## LOCKS AND LATCHES

Mortise Narrow Roller Lock with 92mm CTC with closed case prepared for euro profile cylinders and standard fittings

### PRODUCT CODE

LIM435

### BACKSETS AVAILABLE

30/35mm

### SPECIFICATION

Mortise narrow Roller lock with reversible Latch and 15mm projecting double throw Deadbolt, BS EN12209 inhouse performance tested  
8mm grip tight square follower  
Stainless steel strike plate with dust box 24mm forend available in square corners Supplied with suitable screws and fixings

### QUALITY AND PERFORMANCE

Successfully inhouse type tested for conformity to all the requirements of BS EN12209:2003/AC:2005

### FINISHES

SSS	Satin stainless steel
PSS	Polished stainless steel
PVDB	PVD Black
PVDG	PVD Gold

\*Special finish available upon request subject to minimum order quantity  
\*SS316 available upon request subject to minimum order quantity

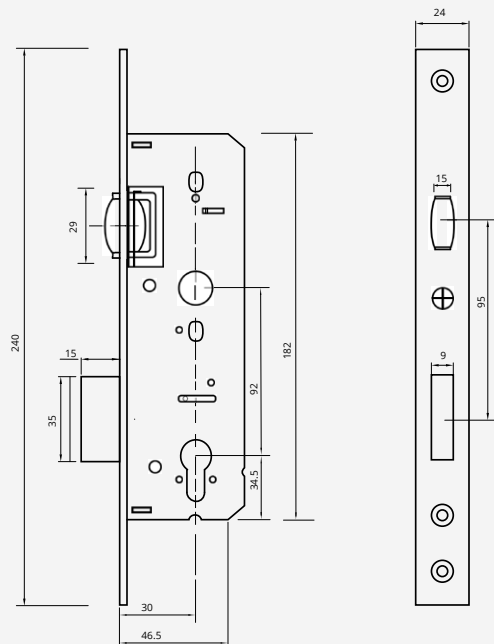

## RESIDENTIAL ENTRANCE LOCK

Residential entrance mortise lockset with thumb turn on inside and cylinder with thumb piece on the outside

### PRODUCT CODE

LIMTP01

### SPECIFICATION

Exterior single cylinder handleset with thumb piece and interior knob and thumb turn  
 70mm backset heavy gauge steel lockcase with 25mm throw stainless steel dead bolt and 19mm throw stainless steel 2 piece latch bolt with anti friction insert. Also includes auxillary stainless steel latch bolt  
 Includes 124mm x 32mm ANSI straight lip strike  
 Suitable for 45mm standard door thickness, optional 35mm and 64mm door thickness Supplied with suitable screws and fixings

### QUALITY AND PERFORMANCE

Successfully inhouse type tested for conformity to all the requirements of ANSI A156.13

### FINISHES

SSS	Satin stainless steel
PSS	Polished stainless steel
PVDB	PVD Black
PVDG	PVD Gold

\*Special finish available upon request subject to minimum order quantity

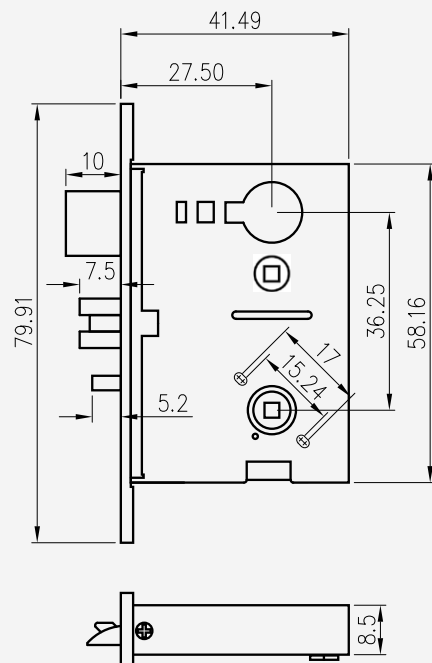

## REBATE KIT

Rebate Kit for DIN Mortise Lockset

### PRODUCT CODE

LIMA01

### SPECIFICATION

- Stainless steel Strike Plate
- Suitable for both Square & Radius profiles.
- Non-Handed
- Supplied with suitable screws and fixings

### QUALITY AND PERFORMANCE

Successfully inhouse type tested for conformity to all the requirements of BS EN12209:2003/AC:2005

### FINISHES

SSS	Satin stainless steel
PSS	Polished stainless steel
PVDB	PVD Black
PVDG	PVD Gold

\*Special finish available upon request subject to minimum order quantity

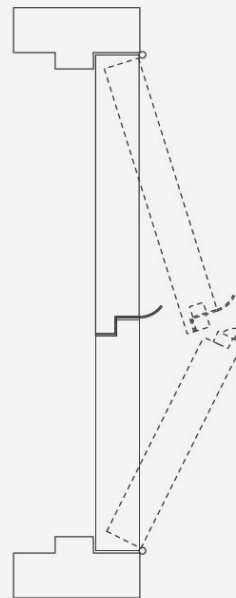

## CYLINDERS AND KEYS

Lockron cylinder range comprises of single, double & turn cylinders with Euro profile bodies. Keyed to differ, keyed alike or master keyed versions are available.



### Did you know...

We offer our own  
bespoke In-house  
Master keying service?

### Available Turn Designs

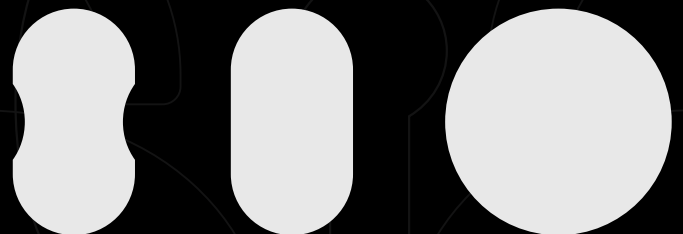

## EURO-PROFILE CYLINDERS

6 pin high security euro-profile single cylinder with one side key operation

PRODUCT CODE	DIMENSION IN MM		
	A	B	L
LIC3506	35	10	45
LIC3506T	35	10	45
LIC3506TP	35	10	45

### SPECIFICATION

Solid brass housing and plugs  
 Top and bottom brass pins  
 9mm wide Cam set in for 30 deg intervals Supplied with three Nickel plated brass Keys with square head for better grip  
 Tested for 100,000 cycles  
 Available in Key Alike and Key differ  
 Suitable for bespoke master key systems Supplied with suitable screws and fixings  
 Add suffix T for half cylinder with thumb turn Add suffix TP for half cylinder with tail piece

### QUALITY AND PERFORMANCE

Successfully inhouse type tested for conformity to all the requirements of BS EN1303

### FINISHES

SNP	Satin Nickel
PNP	Polished Nickel
BLK	Matt Black
PB	Polished Brass

\*Special finish available upon request subject to minimum order quantity

\*Additional length and asymmetric cylinders are available on request

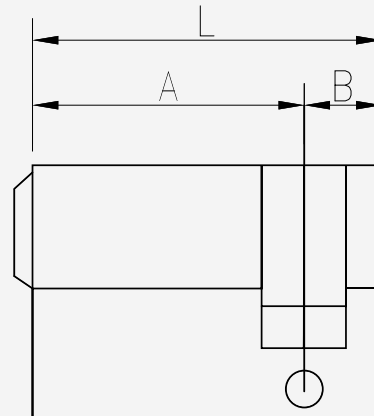

## EURO-PROFILE CYLINDERS

6 pin high security euro-profile double cylinder with both side key operation

PRODUCT CODE	DIMENSION IN MM		
	A	B	L
LIC3026	32.5	32.5	65
LIC3526	35	35	70
LIC4026	40	40	80
LIC4526	45	45	90
LIC5026	50	50	100

### SPECIFICATION

Solid brass housing and plugs  
 Top and bottom brass pins  
 9mm wide Cam set in for 30 deg intervals Supplied with three Nickel plated brass Keys with square head for better grip  
 Tested for 100,000 cycles  
 Available in Key Alike and Key differ  
 Suitable for bespoke master key systems Supplied with suitable screws and fixings

### QUALITY AND PERFORMANCE

Successfully inhouse type tested for conformity to all the requirements of BS EN1303

### FINISHES

SNP	Satin Nickel
PNP	Polished Nickel
BLK	Matt Black
PB	Polished Brass

\*Special finish available upon request subject to minimum order quantity

\*Additional length and asymmetric cylinders are available on request

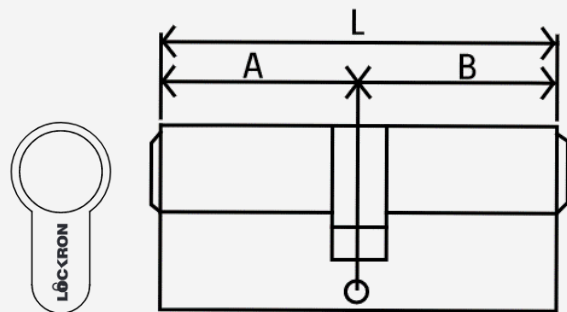

## EURO-PROFILE CYLINDERS

6 pin high security euro-profile thumb turn cylinder with one side key operation and one side thumb turn operation

PRODUCT CODE	DIMENSION IN MM		
	A	B	L
LIC3016	32.5	32.5	65
LIC3516	35	35	70
LIC4016	40	40	80
LIC4516	45	45	90
LIC5016	50	50	100

### SPECIFICATION

Solid brass housing and plugs  
 Top and bottom brass pins  
 9mm wide Cam set in for 30 deg intervals Supplied with three Nickel plated brass Keys with square head for better grip  
 Tested for 100,000 cycles  
 Available in Key Alike and Key differ  
 Suitable for bespoke master key systems Supplied with suitable screws and fixings

### QUALITY AND PERFORMANCE

Successfully inhouse type tested for conformity to all the requirements of BS EN1303

### FINISHES

SNP	Satin Nickel
PNP	Polished Nickel
BLK	Matt Black
PB	Polished Brass

\*Special finish available upon request subject to minimum order quantity  
 \*Additional length and asymmetric cylinders are available on request

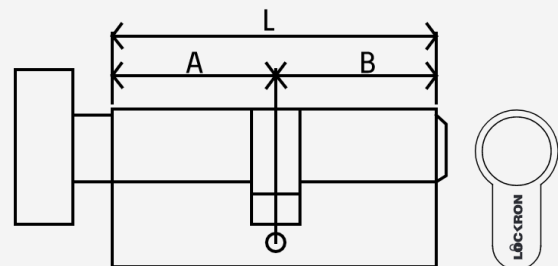

## EURO-PROFILE CYLINDERS

Euro-profile privacy WC cylinder with one side thumb turn operation and one side emergency coin release operation

PRODUCT CODE	DIMENSION IN MM		
	A	B	L
LIC3016WC	32.5	32.5	65
LIC3516WC	35	35	70
LIC4016WC	40	40	80

### SPECIFICATION

Solid brass housing and plugs  
9mm wide Cam set in for 30 deg intervals Tested for 100,000 cycles  
Supplied with suitable screws and fixings

### FINISHES

SNP	Satin Nickel
PNP	Polished Nickel
BLK	Matt Black
PB	Polished Brass

\*Special finish available upon request subject to minimum order quantity  
\*Additional length and asymmetric cylinders are available on request

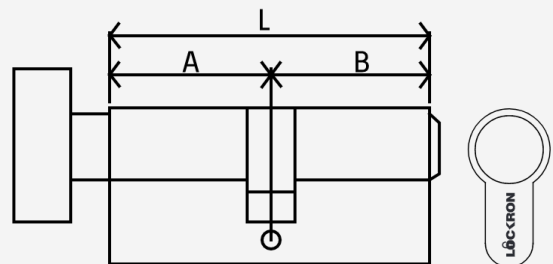

# HINGES AND PIVOTS

Lockron Hinges and Pivots includes Ball bearing hinges, Rising hinges, Concealed hinges and more in a variety of exquisite finishes.

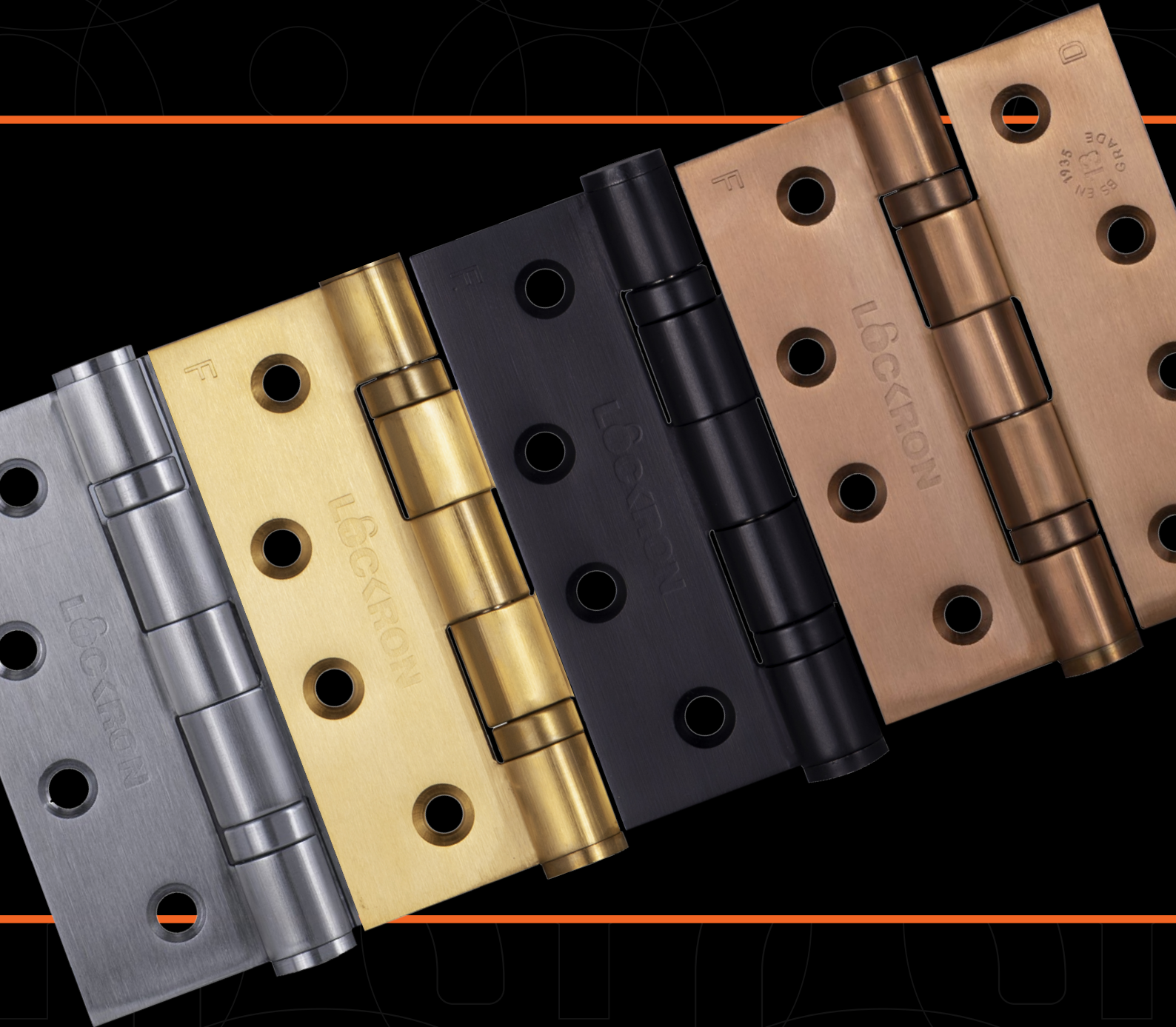

Featured Product

**LIH4330**

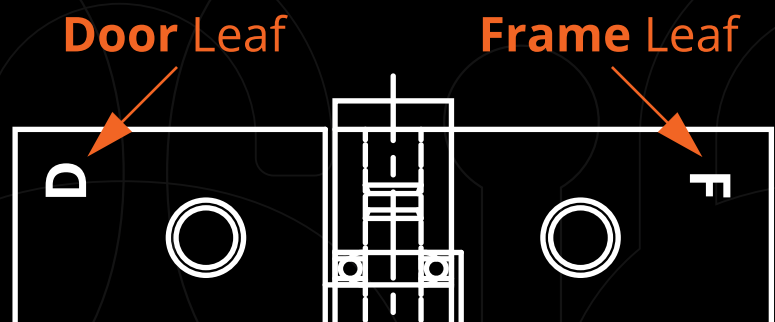

## BALL BEARING HINGES

2 Ball bearing hinge Grade 13 – Stainless Steel

PRODUCT CODE	DIMENSION
LIH4330	102mm x 76mm x 3mm
LIH4353	102mm x 89mm x 3mm
LIH4430	102mm x 102mm x 3mm
LIH4543	114mm x 102mm x 3mm
LIH4545	114mm x 114mm x 3mm

### SPECIFICATION

High performance two ball bearing butt hinges Stainless steel hinge pin  
Grade 13, conforming to BS EN 1935, CE marked  
Template drilled fixing pattern  
Suitable for use on doors up to 120kg Available in square and round corners 2 hinges per box supplied (pair)

### QUALITY AND PERFORMANCE

Successfully type tested for conformity to all the requirements of BS EN1935:2002

4 7 6 1 1 4 0 13

### FINISHES

SSS	Satin stainless steel
PSS	Polished stainless steel
PCB	Powder coated black
PVDB	PVD Black
PVDG	PVD Gold

\*Special finish available upon request subject to minimum order quantity

\*SS316 available upon request subject to minimum order quantity

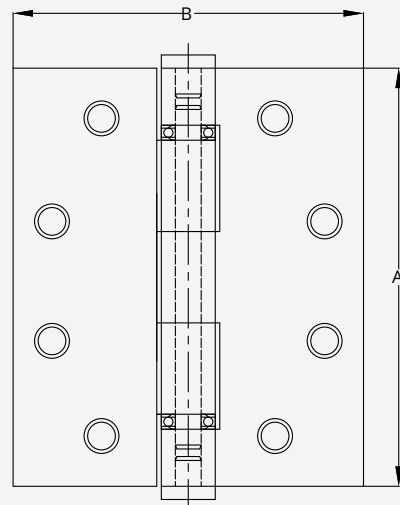

**HINGES**

DOOR HARDWARE

**RISING HINGES**

Heavy duty rising hinge

PRODUCT CODE	DIMENSION
LIRH4330R	102mm x 76mm x 3mm
LIRH4330L	102mm x 76mm x 3mm

**SPECIFICATION**

- Heavy duty rising hinge
- Stainless steel SS304 grade hinge flaps and pin
- Template drilled fixing pattern
- Available in square corners only
- Handed, mention correct handing while ordering 2 hinges per box supplied (pair)

**FINISHES**

SSS	Satin stainless steel
PSS	Polished stainless steel
PCB	Powder coated black
PVDB	PVD Black
PVDG	PVD Gold

\*Special finish available upon request subject to minimum order quantity  
\*SS316 available upon request subject to minimum order quantity

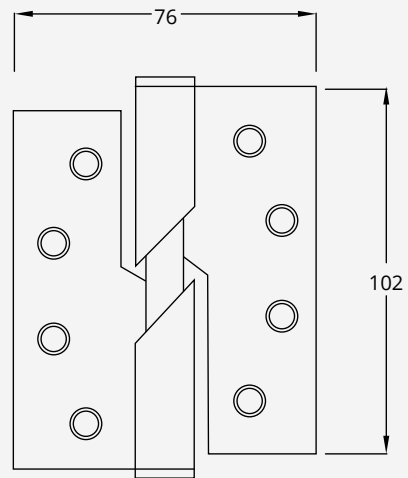

## PARLIAMENT HINGE

Heavy duty Parliament hinge

PRODUCT CODE	DIMENSION
LIHP4430	100 x 51 x100 x 3mm

### SPECIFICATION

Heavy duty parliament hinge  
Stainless steel SS304 grade  
With suitable fixing screws

### FINISHES

SSS	Satin stainless steel
PSS	Polished stainless steel
PCB	Powder coated black
PVDB	PVD Black
PVDG	PVD Gold

\*Special finish available upon request subject to minimum order quantity

\*SS316 available upon request subject to minimum order quantity

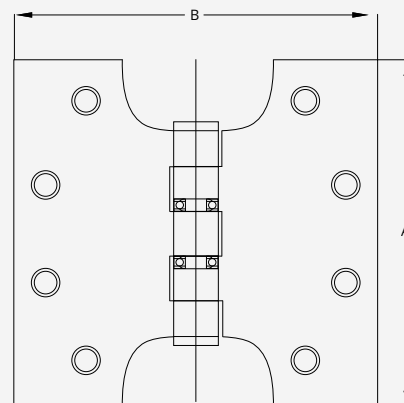

**HINGES**

**CONCEALED HINGES**

Concealed Invisible hinges

**SPECIFICATION**

- Drill in concealed hinges with zinc alloy body Stainless steel linkages
- Non-handed design
- Available in various sizes
- Supplied with suitable screws and fixings

**FINISHES**

SCP	Satin Chrome plated
PC	Polished Chrome
SN	Satin Nickel
PB	Polished Brass
AB	Antique Bronze

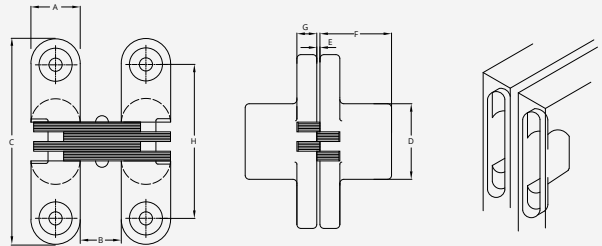

MODEL	A	B	C	D	E	F	G	H	Thickness & deviation of each connection
LICCH003	12.4	8.8	437	18.7	0.8	18.3	4.9	31.7	1.12±0.02
LICCH004	12.7	8.1	8.1	60.4	30	0.8	17.8	5.6	1.15±0.02
LICCH005	15.7	11.5	68.8	33.7	1.0	22.7	7.0	51.8	1.45±0.02
LICCH006	18.4	12.6	94	54.5	1.0	26.8	8.7	74	1.95±0.02
LICCH007	24.7	18.0	115.8	63.8	1.23	36.5	10.5	105	1.45±0.02
LICCH008	27.8	23.0	116.0	61.3	1.20	41.0	9.1	81.2 87.8	2.45±0.02
LICCH009	33.6	28.2	137.2	73.8	1.30	49.5	11.0	113.5 102.4	2.45±0.02

Dimensions are in mm

## CONCEALED HINGES

3D adjustable Concealed hinge

PRODUCT CODE	DIMENSION
LICCH1773D	177mm x 28mm

### SPECIFICATION

Concealed Hinge 3D adjustable  
 Load Capacity: 80kgs/2pcs  
 Height: 177mm  
 Width: Frame-28mm/Leaf-28mm Depth: Frame-24.5mm/Leaf-24.5mm Min. door thickness: 40mm  
 Opening Angle: 180degrees  
 Suitable for both wood and metal doors

### 3D-ADJUSTABLE

Side : +/- 2mm  
 Height : +/-3mm  
 Depth : +/- 1mm

PRODUCT CODE	DIMENSION
LICCH2463D	246mm x 34mm

### SPECIFICATION

Concealed Hinge 3D adjustable  
 Load Capacity: 120kgs/2pcs  
 Height: 246mm  
 Width: Frame-34mm/Leaf-34mm Depth: Frame-26.5mm/Leaf-26.5mm Min. door thickness: 45mm  
 Non-Handed Design  
 Opening Angle: 180degrees  
 Suitable for both wood and metal doors

### 3D-ADJUSTABLE

Side : +/- 2mm  
 Height : +/-3mm  
 Depth : +/- 1mm

### FINISHES

SIL	Silver
BK	Black

\*Special finish available upon request subject to minimum order quantity

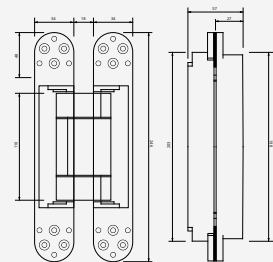
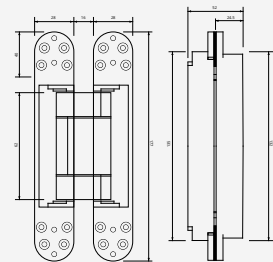

## PIVOTS

Square Pivot hinge set

### PRODUCT CODE

LISPS01S

### SPECIFICATION

Double action pivot set designed to allow the door to open outwards in the case of an emergency  
Maximum door weight 80kg  
Manufactured from Stainless steel SS304 grade Suitable for use in all domestic, industrial and commercial environments.  
Supplied with suitable screws and fixings

### FINISHES

SSS Satin stainless steel



## **DOOR CONTROLS**

Lockron range of Door Controls includes surface and concealed mounted door closers, floor springs with load capacity upto 300kg and door coordinators.



Featured Product

**LID5024**

**Available Forends**

## OVERHEAD SURFACE MOUNTED DOOR CLOSER

EN 2-4 power adjustable overhead surface mounted door closer with standard arm

### PRODUCT CODE

LID5003

### DIMENSION

Length :182mm  
Width :39.5mm  
Depth :62.5mm

### SPECIFICATION

Spring power EN 2-4 adjustable size  
Power adjustment by position  
Conforming to BS EN 1154,CE marked  
Suitable for door width from 850 to 1100mm Non-handed design with adjustable closing speed and latching speed  
Suitable for regular, parallel arm and transom mounting application  
Supplied with suitable screws and fixings

### QUALITY AND PERFORMANCE

Successfully type tested for conformity to all the requirements of BS EN1154:1996

4	8	2-4	1	1	4
---	---	-----	---	---	---

UL/cUL listed for up to 3 hours  
UL10C Positive Pressure Rated

### FINISHES

SIL	Silver
BLK	Black
WHT	White

\*Special finish available upon request subject to minimum order quantity

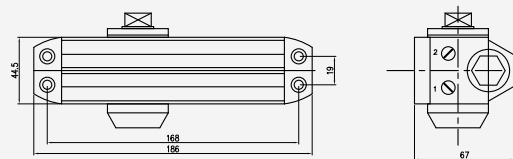

## OVERHEAD SURFACE MOUNTED DOOR CLOSER

EN 2-4 power adjustable overhead surface mounted door closer with standard arm

### PRODUCT CODE

LID5234 – EN 2-4 Door closer  
LID5234COV – EN 2-4 Door closer with Cover

### DIMENSION

Length : 220mm  
Width : 53.5mm  
Depth : 46mm

### SPECIFICATION

Spring power EN 2-4 adjustable size  
Power adjustment by position  
Conforming to BS EN 1154, CE marked  
Suitable for door width from 850 to 1100mm  
Non-handed design with adjustable closing speed and latching speed  
Suitable for regular, parallel arm and transom mounting application  
Supplied with suitable screws and fixings

### QUALITY AND PERFORMANCE

Successfully type tested for conformity to all the requirements of BS EN1154:1996



### FINISHES

SIL	Silver
BLK	Black
SSS	Satin Stainless Steel finish (Cover and Arm)

\*Special finish available upon request subject to minimum order quantity

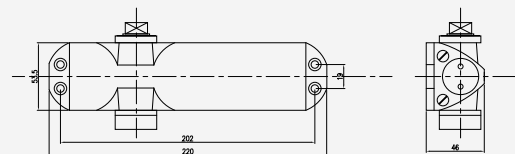

## OVERHEAD SURFACE MOUNTED DOOR CLOSER

EN 2-4 spring adjustable overhead surface mounted door closer with standard flat arm, parallel arm bracket and door closer cover

### PRODUCT CODE

LID5024

### DIMENSION

Length : 252mm

Width : 67mm

Depth : 54mm

### SPECIFICATION

Spring power EN 2-4 adjustable size

Power adjustment by spring

Conforming to BS EN 1154, CE marked

Suitable for door width from 850 to 1100mm Adjustable

back check and delayed action feature Non-handed

design with adjustable closing speed and latching speed

Suitable for regular, parallel arm and transom mounting application

Supplied with suitable screws and fixings

### QUALITY AND PERFORMANCE

Successfully type tested for conformity to all the requirements of BS EN1154:1996

3	8	4-2	1	1	2
---	---	-----	---	---	---

### FINISHES

SIL	Silver
SN	Satin Nickel
PN	Polished Nickel
BLK	Black
PB	Polished Brass

\*Special finish available upon request subject to minimum order quantity

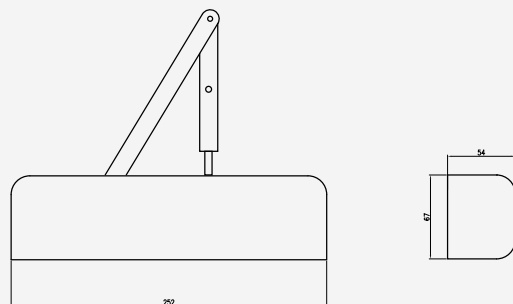

## OVERHEAD SURFACE MOUNTED DOOR CLOSER

EN 3-6 spring adjustable overhead surface mounted door closer with standard flat arm, parallel arm bracket and door closer cover

### PRODUCT CODE

LID5036

### DIMENSION

Length : 300mm

Width : 70mm

Depth : 60mm

### SPECIFICATION

Spring power EN 3-6 adjustable size

Power adjustment by spring

Conforming to BS EN 1154, CE marked

Suitable for door width from 950 to 1400mm Adjustable

back check and delayed action feature Non-handed

design with adjustable closing speed and latching speed

Suitable for regular, parallel arm and transom mounting application

Supplied with suitable screws and fixings

### QUALITY AND PERFORMANCE

Successfully type tested for conformity to all the requirements of BS EN 1154:1996

3	8	3-6	1	1	2
---	---	-----	---	---	---

### FINISHES

SIL	Silver
SN	Satin Nickel
PN	Polished Nickel
BLK	Black
PB	Polished Brass

\*Special finish available upon request subject to minimum order quantity



SN



PN



PB



BLK

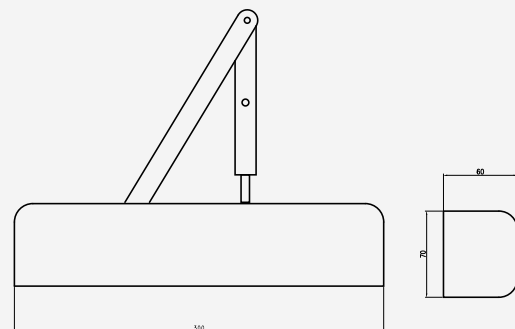

## OVERHEAD CONCEALED DOOR CLOSER

EN 3 spring fixed size overhead concealed door closer with slide channel assembly suitable for door thickness 45mm and more.

### PRODUCT CODE

LID6003

### DIMENSION

Length : 230mm

Width : 32mm

Depth : 57mm

### SPECIFICATION

Spring power EN 3 fixed size

Suitable for door width up to 1000mm Non-handed

design with adjustable closing speed and latching speed

Suitable for regular and transom mounting application

with optional hold open feature Supplied with suitable screws and fixings

### QUALITY AND PERFORMANCE

Successfully inhouse type tested for conformity to all the requirements of BS EN1154

UL/cUL listed for up to 3 hours

UL10C Positive Pressure Rated

### FINISHES

SIL	Silver
BLK	Black
PC	Polished Chrome

\*Special finish available upon request subject to minimum order quantity

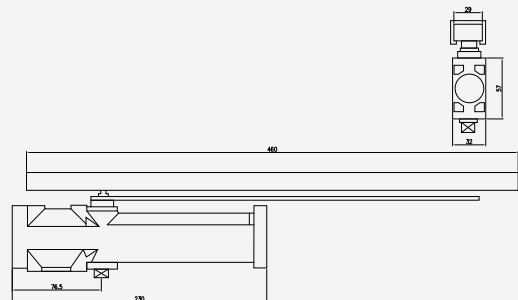

## OVERHEAD CONCEALED DOOR CLOSER

EN 2-4 spring adjustable overhead concealed door closer with slide channel assembly suitable for door thickness 45mm and more.

### PRODUCT CODE

LID6024

### DIMENSION

Length : 230mm

Width : 37mm

Depth : 61mm

### SPECIFICATION

Spring power EN 2-4 power adjustable by spring

Suitable for door width from 850mm to 1100mm

Non-handed design with adjustable closing speed and latching speed

Suitable for regular and transom mounting application with optional backcheck and hold open feature

Supplied with suitable screws and fixings

### QUALITY AND PERFORMANCE

Successfully inhouse type tested for conformity to all the requirements of BS EN1154

UL/cUL listed for up to 3 hours

UL10C Positive Pressure Rated

### FINISHES

SIL	Silver
BLK	Black
PC	Polished Chrome

\*Special finish available upon request subject to minimum order quantity

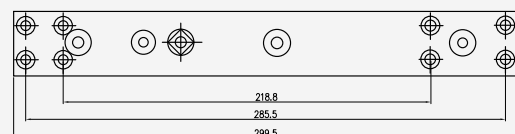
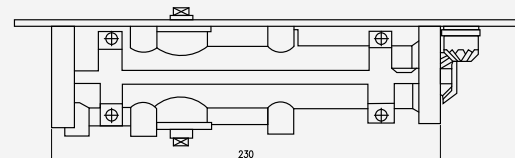

## OVERHEAD CONCEALED DOOR CLOSER

EN 2-4 spring adjustable overhead CAM action concealed door closer with slide channel assembly suitable for door thickness 45mm and more.

### PRODUCT CODE

LID6024C

### DIMENSION

Length : 240mm

Width : 32mm

Depth : 46mm

### SPECIFICATION

Spring power EN 2-4 power adjustable by spring  
Cam action technology offering a much lower opening resistance while delivering optimum closing force and control

Suitable for door width from 850mm to 1100mm

Non-handed design with adjustable closing speed and latching speed

With adjustable backcheck feature

Suitable for regular and transom mounting application with optional hold open feature Supplied with suitable screws and fixings

### QUALITY AND PERFORMANCE

Successfully inhouse type tested for conformity to all the requirements of BS EN1154

UL/cUL listed for up to 3 hours

UL10C Positive Pressure Rated

### FINISHES

SIL	Silver
BLK	Black
PC	Polished Chrome

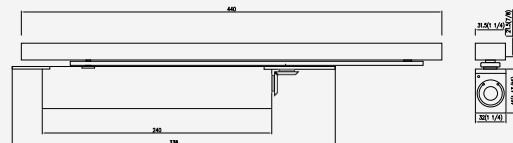



## FLOOR SPRING

LIF7000 series EN 3/4/5 fixed size floor spring

PRODUCT CODE	LIF7003	LIF7004	LIF7005
Closing Force	3	4	5
Door width mm	950	1100	1250
Door weight Kg	100	120	150

### DIMENSION

Length : 324mm

Width : 108mm

Depth : 41mm

### SPECIFICATION

Fixed Spring power EN 3/4/5

Cam action technology offering a much lower opening resistance while delivering optimum closing force and control

Suitable for door widths 950/1100/1250mm Non-handed design with adjustable closing speed and latching speed

Maximum door opening angle 130 degrees

90 degrees hold open as default

Supplied with suitable screws and fixings

### QUALITY AND PERFORMANCE

Successfully inhouse type tested for conformity to all the requirements of BS EN1154

### FINISHES

SSS	Satin Stainless Steel
PSS	Polished Stainless Steel

### ACCESSORIES

LIFA7101-150KG Double Action

LIFA7102-150KG Single Action

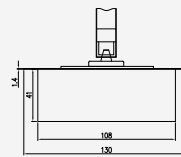
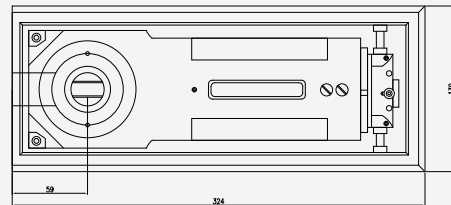

LIFA7102-150KG



## FLOOR SPRING

LIF7300 series EN 6 fixed size floor spring

### PRODUCT CODE

LIF7300

Closing Force 6  
Door width mm 1400  
Door weight Kg 300

### DIMENSION

Length : 341mm  
Width : 78mm  
Depth : 60mm

### SPECIFICATION

Fixed Spring power EN 6  
Cam action technology offering a much lower opening resistance while delivering optimum closing force and control  
Suitable for door width 1400mm  
Non-handed design with adjustable closing speed and latching speed  
Maximum door opening angle 180 degrees  
90 degrees hold open as default  
Supplied with suitable screws and fixings

### QUALITY AND PERFORMANCE

Successfully inhouse type tested for conformity to all the requirements of BS EN1154

### FINISHES

SSS	Satin Stainless Steel
PSS	Polished Stainless Steel

\*Special finish available upon request subject to minimum order quantity

### ACCESSORIES

LIFA7103-300KG Double Action  
LIFA7104-300KG Single Action

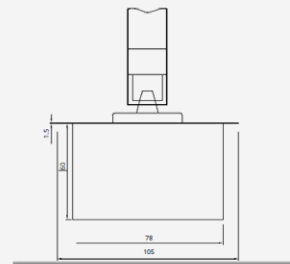
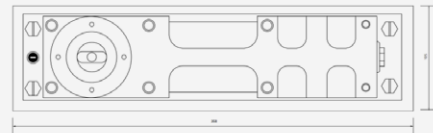

## DOOR COORDINATORS

Door coordinators for various applications.

### PRODUCT CODE

LIDA5201

### SPECIFICATION

Gravity type door coordinator  
Adjustable gravity arm and door brackets Supplied with suitable screws and fixings Satin stainless steel finishes



### PRODUCT CODE

LIDA5202

### SPECIFICATION

Spring arm door selector  
Supplied with suitable screws and fixings Satin stainless steel finish



### PRODUCT CODE

LIDA5203

### SPECIFICATION

Stop mounted door coordinator  
Filler bar and mounting brackets to be ordered separately.  
52" standard size. Available in custom sizes also.  
Supplied with suitable screws and fixings  
Satin stainless steel finish



# **PANIC EXIT DEVICES**

Lockron Panic Exit device series consists of Rim and surface vertical rod devices complimented with matching passage and entrance function outside access devices



**Featured Product**

**LIE2001**

## **Available OAD Options**

Euro profile  
cut-out Trim



Key-in Sectional  
Trim

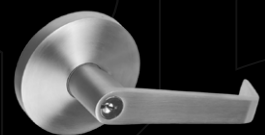

## PANIC EXIT DEVICE

Modular touch bar panic latch and panic bolt reliably secures egress doors in compliance with all applicable fire/life safety code requirements

### PRODUCT CODE

#### Panic Latch

LIE2001A for door width up to 1100mm

LIE2001B for door width up to 1400mm

#### Panic Bolt

LIE2002C for door height up to 2200mm

LIE2002D for door height up to 3000mm

### SPECIFICATION

Modular touch bar panic exit devices suitable for fire and smoke check door assemblies  
Security anti thrust latch mechanism dead locks latch bolt  
Non-handed design  
Available in steel painted and SS304 grade Supplied with suitable screws and fixings

### QUALITY AND PERFORMANCE

Successfully inhouse type tested for conformity to all the requirements of BS EN1125  
UL/cUL listed for up to 3 hours  
UL10C Positive Pressure Rated

### FINISHES

SIL	Silver
SSS	Satin stainless steel
PSS	Polished stainless steel

\*Special finish available upon request subject to minimum order quantity



## OUTSIDE ACCESS DEVICE

LIE2100 series outside access devices to gain access through emergency exit doors from outside.

### PRODUCT CODE

LIE2105

### SPECIFICATION

Prepared for 45mm euro-profile half cylinders Available in Entrance function only  
Non handed design  
Supplied with suitable screws and fixings

### PRODUCT CODE

LIE2106

### SPECIFICATION

Key-in sectional outside access device Available in Entrance (Suffix E) and passage (Suffix P) function  
Non handed design  
Supplied with suitable screws and fixings

### PRODUCT CODE

LIE2107

### SPECIFICATION

Prepared for 45mm euro-profile half cylinders Available in Entrance (Suffix E) and passage (Suffix P) function  
Non handed design  
Supplied with suitable screws and fixings

### FINISHES

SIL	Silver
SSS	Satin stainless steel
PSS	Polished stainless steel

\*Special finish available upon request subject to minimum order quantity



LIE2105E



LIE2106E



LIE2107E



## OUTSIDE ACCESS DEVICE

LIE2100 series outside access devices to gain access through emergency exit doors from outside.

### PRODUCT CODE

LIE2108E

### SPECIFICATION

Key-in sectional outside access knob device Available in Entrance function only  
Non handed design  
Supplied with suitable screws and fixings

### FINISHES

SSS Satin stainless steel

\*Special finish available upon request subject to minimum order quantity



## EXIT DEVICE ACCESSORIES

### PRODUCT CODE

LIE2102

### SPECIFICATION

Overlapping strike for rim exit devices when used with double doors  
Strike is installed on the inactive door of the pair  
Supplied with suitable screws and fixings



## OUTSIDE ACCESS DEVICE

Electric strikes for panic exit devices

### PRODUCT CODE

LIE2103

### SIZE

230mm x 40mm x 30mm

### SPECIFICATION

Electric strikes for Rim panic exit device on single leaf door

Voltage input: DC12V or 24V

Current draw: 12V/220mA or 24V/110mA Holding

Force: up to 1000kg

Operating temperature: -10°C ~ +55°C Available in Fail safe and Fail secured

### FINISHES

BLK Black

### PRODUCT CODE

LIE2104

### SIZE

153.5mm x 43mm x 49mm

### SPECIFICATION

Electric strikes for Rim panic exit device on double leaf door

Voltage input: DC12V or 24V

Current draw: 12V/320mA or 24V/160mA Holding

Force: up to 1000kg

Operating temperature: -10°C ~ +55°C Available in Fail safe and Fail secured

### FINISHES

SIL Silver





## ACCESSORIES

Lockron door hardware accessories consists of door stops, WC indicators, door holders, door guards, sign plates, flush pulls, flush bolts, push plates and more.



Featured Product

**LIA8009**

ACCESSORIES

DOOR HARDWARE

## ESCUTCHEONS

Blank/Euro-profile escutcheons

### PRODUCT CODE

- LIA8001 – Blank profile Escutcheons
- LIA8002 – Euro-profile round escutcheons
- LIA8003 – Euro-profile Oval escutcheons
- LIA8004 – Euro-profile Square escutcheons

### SPECIFICATION

Escutcheons prepared to suit euro-profile cylinders  
Push on rose fixing with 8mm projection Manufactured from stainless steel SS304 grade Supplied with suitable screws and fixings

### FINISHES

SSS	Satin stainless steel
PSS	Polished stainless steel

\*Special finish available upon request subject to minimum order quantity

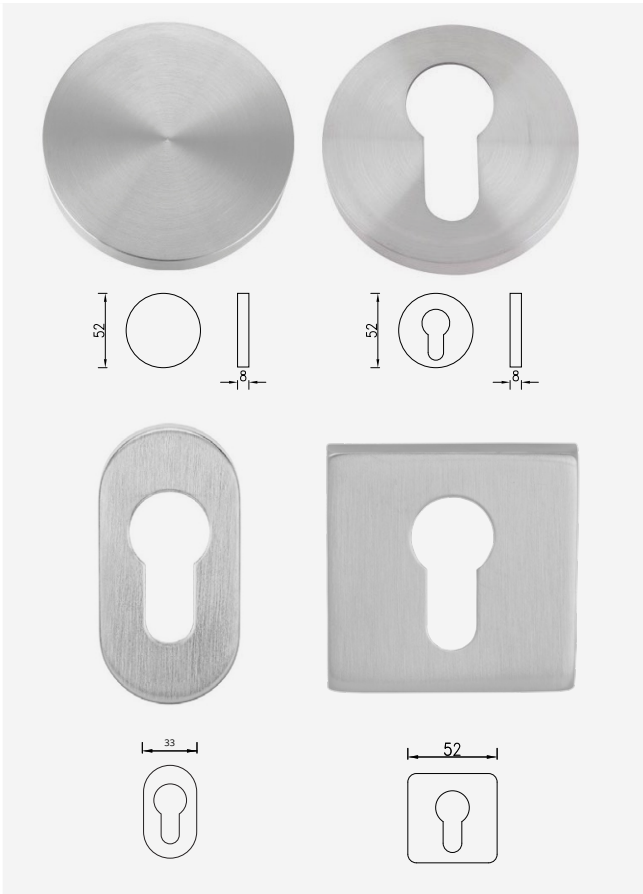

## WC INDICATORS

Large Thumb Turn & Emergency coin release with Indicator

### PRODUCT CODE

LIA8005

### SPECIFICATION

52mm diameter large Thumb Turn & Emergency Release WC indicator  
Supplied with 8mm Square spindle  
Suitable up to 55mm door thickness Manufactured from Stainless steel SS304 grade Supplied with suitable screws and fixings

### FINISHES

SSS	Satin stainless steel
PSS	Polished stainless steel

\*Special finish available upon request subject to minimum order quantity

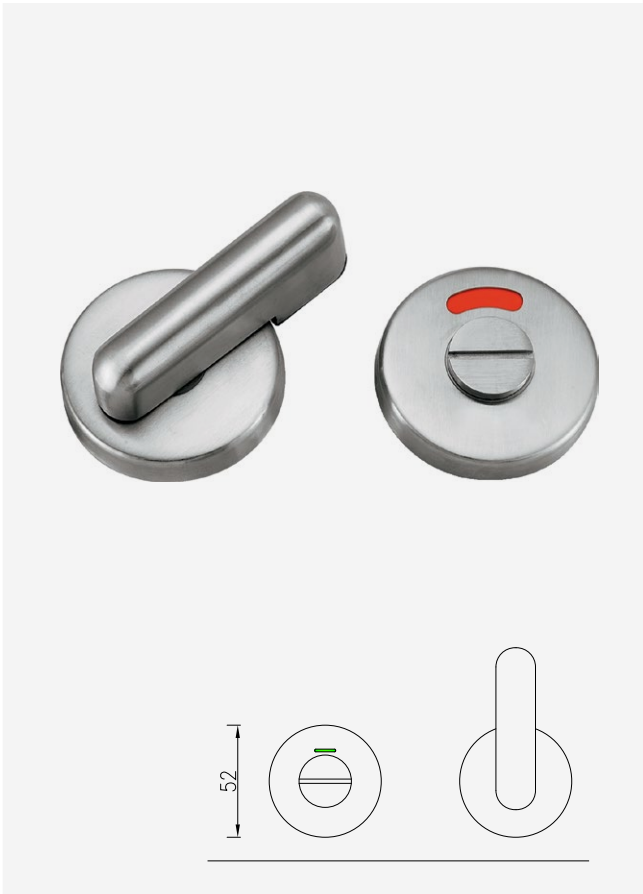

### WC INDICATORS

Large Thumb Turn & Emergency coin release with Indicator

**PRODUCT CODE**

LIA8005R - Round Rose  
LIA8005S - Square Rose

**SPECIFICATION**

52mm Round / Square Thumb Turn & Emergency Release WC indicator  
Supplied with 8mm Square spindle  
Suitable up to 55mm door thickness Manufactured from Stainless steel SS304 grade Supplied with suitable screws and fixings

**FINISHES**

SSS	Satin stainless steel
PSS	Polished stainless steel

\*Special finish available upon request subject to minimum order quantity

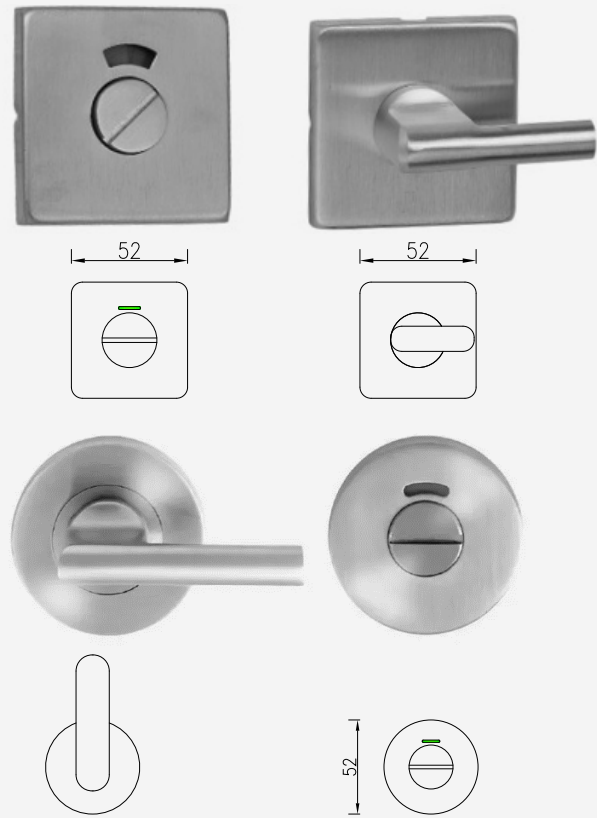

### WC INDICATORS

Thumb Turn & Emergency coin release with Indicator

**PRODUCT CODE**

LIA8006

**SPECIFICATION**

52mm diameter Thumb Turn & Emergency Release WC indicator  
Supplied with 8mm Square spindle  
Suitable up to 55mm door thickness Manufactured from Stainless steel SS304 grade Supplied with suitable screws and fixings

**FINISHES**

SSS	Satin stainless steel
PSS	Polished stainless steel

\*Special finish available upon request subject to minimum order quantity



ACCESSORIES

DOOR HARDWARE

**WC INDICATORS**

Thumb Turn & Emergency coin release with Indicator

**PRODUCT CODE**

LIA8006S

**SPECIFICATION**

52mm Square Thumb Turn & Emergency Release WC indicator  
Supplied with 8mm Square spindle  
Suitable up to 55mm door thickness Manufactured from Stainless steel SS304 grade Supplied with suitable screws and fixings

**FINISHES**

SSS	Satin stainless steel
PSS	Polished stainless steel

\*Special finish available upon request subject to minimum order quantity

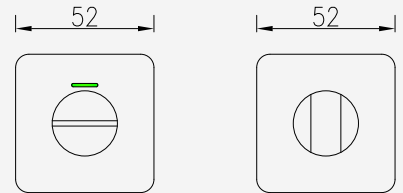

**WC INDICATORS**

Thumb Turn & Emergency coin release with Indicator

**PRODUCT CODE**

LIA8006Z

**SPECIFICATION**

52mm diameter Thumb Turn & Emergency Release WC indicator  
5mm Square spindle  
Supplied with 8mm spindle converter Manufactured from Stainless steel SS304 grade Supplied with suitable screws and fixings

**FINISHES**

SSS	Satin stainless steel
PSS	Polished stainless steel

\*Special finish available upon request subject to minimum order quantity

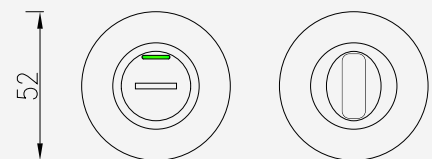

## DOOR STOPS

Door stop floor mounted – Half dome door stop  
45mm diameter with locating pin

### PRODUCT CODE

LIA8007

### SPECIFICATION

Floor mounted half dome door stop Stainless steel  
SS304 grade  
45mm diameter  
With locating pin  
Supplied with suitable screws and fixings

### FINISHES

SSS	Satin stainless steel
PSS	Polished stainless steel

\*Special finish available upon request subject to minimum order quantity

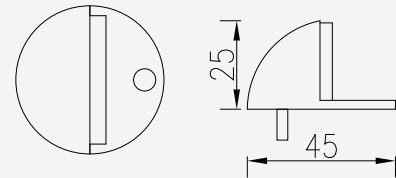

## DOOR STOPS

Cove door stop floor mounted

### PRODUCT CODE

LIA8008

### SPECIFICATION

Floor mounted Cove door stop  
Stainless steel SS304 grade  
17mm height  
56.5 x 45.5mm Overall size  
Supplied with suitable screws and fixings

### FINISHES

SSS	Satin stainless steel
PSS	Polished stainless steel

\*Special finish available upon request subject to minimum order quantity

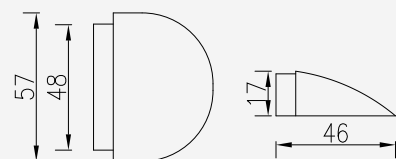

ACCESSORIES

DOOR HARDWARE

**DOOR STOPS**

Door stop floor mounted - round collared flat top 35mm diameter

**PRODUCT CODE**

LIA8009  
LIA8009D

**SPECIFICATION**

Floor mounted pedestal door stop Stainless steel SS304 grade  
35mm diameter  
30 x 40mm Overall size  
Supplied with suitable screws and fixings

**FINISHES**

SSS	Satin stainless steel
PSS	Polished stainless steel

\*Special finish available upon request subject to minimum order quantity

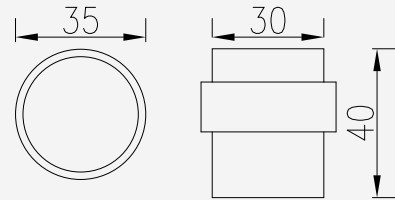

**DOOR STOPS**

Door stop wall mounted – Cylindrical projecting wall stop with rose

**PRODUCT CODE**

LIA8010

**SPECIFICATION**

Wall mounted 80mm projecting door stop Stainless steel SS304 grade  
38mm diameter rose with concealed fixing Supplied with suitable screws and fixings

**FINISHES**

SSS	Satin stainless steel
PSS	Polished stainless steel

\*Special finish available upon request subject to minimum order quantity

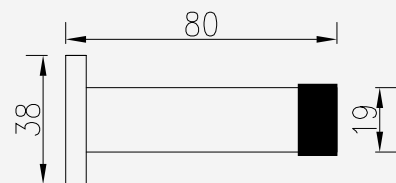

## DOOR STOPS

Concave wall mounted door stop

### PRODUCT CODE

LIA8011

### SPECIFICATION

Wall mounted concave door stop Stainless steel SS304 grade  
61mm diameter and 25mm projection Supplied with suitable screws and fixings

### FINISHES

SSS	Satin stainless steel
PSS	Polished stainless steel

\*Special finish available upon request subject to minimum order quantity

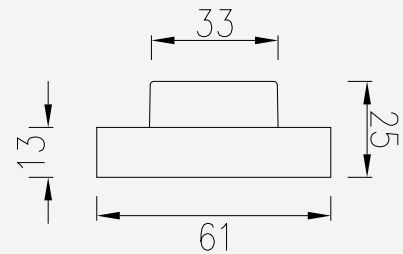

## HAT AND COAT HOOK

Hat and coat hook with rubber buffer

### PRODUCT CODE

LIA8012

### SPECIFICATION

20mm wide Face fixing hat and coat hook with 76mm projection  
Comes with rubber buffer  
Stainless steel SS304 grade  
Supplied with suitable screws and fixings

### FINISHES

SSS	Satin stainless steel
PSS	Polished stainless steel

\*Special finish available upon request subject to minimum order quantity

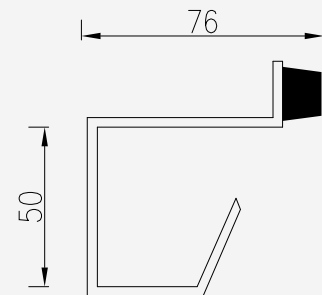

ACCESSORIES

DOOR HARDWARE

**DOOR STOPS**

Door stop wall mounted – Circular projecting wall stop

**PRODUCT CODE**

LIA8013

**SPECIFICATION**

Wall mounted 98mm projecting door stop Stainless steel SS304 grade  
46mm diameter rose with surface fixing Supplied with suitable screws and fixings

**FINISHES**

SSS	Satin stainless steel
PSS	Polished stainless steel

\*Special finish available upon request subject to minimum order quantity

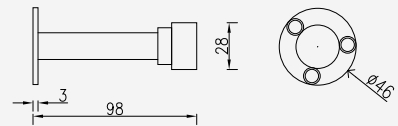

**DOOR STOPS**

Door stop wall mounted – Circular projecting wall stop with hook

**PRODUCT CODE**

LIA8014

**SPECIFICATION**

Wall mounted 98mm projecting door stop with hook Stainless steel SS304 grade  
46mm diameter rose with surface fixing Supplied with suitable screws and fixings

**FINISHES**

SSS	Satin stainless steel
PSS	Polished stainless steel

\*Special finish available upon request subject to minimum order quantity

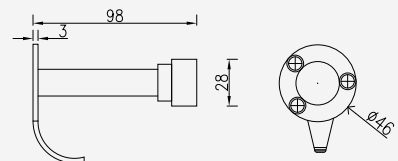

## DOOR HOLDER

Concave wall mounted door stop

### PRODUCT CODE

LIA8015

### SPECIFICATION

Floor mounted magnetic door holder Material : Zinc Alloy  
Supplied with suitable screws and fixings

### FINISHES

SSS	Satin stainless steel
PSS	Polished stainless steel

\*Special finish available upon request subject to minimum order quantity

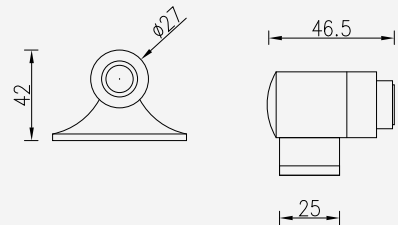

## DOOR HOLDER

Floor mounted door holder

### PRODUCT CODE

LIA8016

### SPECIFICATION

Floor mounted magnetic door holder  
Material : Zinc Alloy  
Supplied with suitable screws and fixings

### FINISHES

SSS	Satin stainless steel
PSS	Polished stainless steel

\*Special finish available upon request subject to minimum order quantity

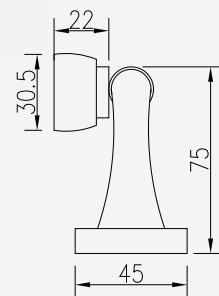

ACCESSORIES

DOOR HARDWARE

**DOOR HOLDER**

Foot operated door mounted door holder

**PRODUCT CODE**

LIA8017

**SPECIFICATION**

Foot operated door mounted door holder Material : Zinc Alloy  
Supplied with suitable screws and fixings

**FINISHES**

SNP	Satin Nickel Plated
PNP	Polished Nickel Plated

\*Special finish available upon request subject to minimum order quantity

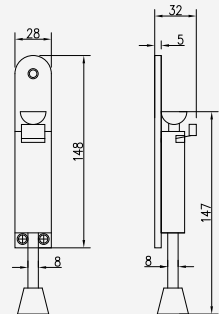

**DOOR GUARD**

Security chain door guard - Surface mounted

**PRODUCT CODE**

LIA8018

**SPECIFICATION**

Security Chain door guard surface mounted for main door application  
Stainless steel SS304 grade  
Supplied with suitable screws and fixings

**FINISHES**

SSS	Satin stainless steel
PSS	Polished stainless steel

\*Special finish available upon request subject to minimum order quantity

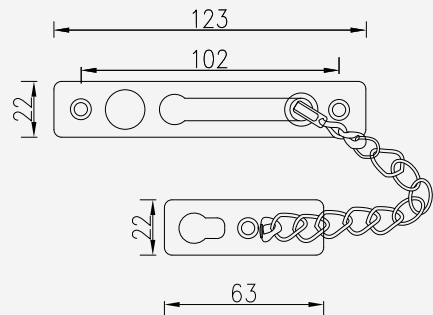

## DOOR GUARD

Security chain door guard - Concealed

### PRODUCT CODE

LIA8019

### SPECIFICATION

Security Chain door guard Concealed fixing for main door application

Material : Zinc Alloy

Supplied with suitable screws and fixings

### FINISHES

SNP	Satin Nickel Plated
PNP	Polished Nickel Plated

\*Special finish available upon request subject to minimum order quantity

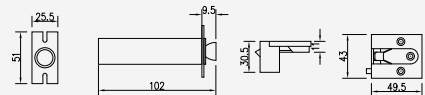

## DOOR GUARD

Security Door guard – Surface Mounted

### PRODUCT CODE

LIA8020

### SPECIFICATION

Security door guard surface mounted for main door application

Material : Zinc Alloy

Supplied with suitable screws and fixings

### FINISHES

SNP	Satin Nickel Plated
PNP	Polished Nickel Plated

\*Special finish available upon request subject to minimum order quantity

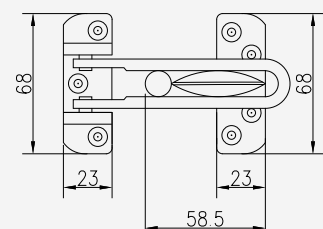
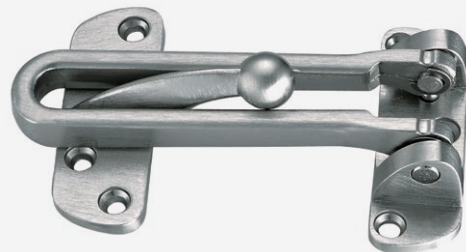

ACCESSORIES

DOOR HARDWARE

**LOCKS AND LATCHES**

Mortise deadbolt lock for WC

**PRODUCT CODE**

LIA8021

**SPECIFICATION**

Mortise lock with projecting dead bolt 8mm follower to suit WC indicators Stainless steel forend and strike plate  
Supplied with suitable screws and fixings

**FINISHES**

SSS	Satin stainless steel
PSS	Polished stainless steel

\*Special finish available upon request subject to minimum order quantity

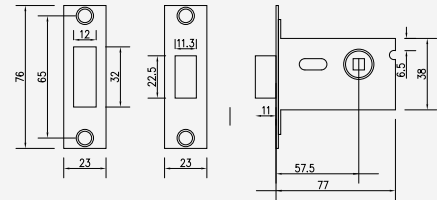

**CYLINDER PULL**

Cylinder Pull Handle – Face fixing

**PRODUCT CODE**

LIA8028 - with euro-profile cut out  
LIA8029 - without euro-profile cut out

**SPECIFICATION**

Cylinder Pull handle – face fixing  
With and without euro-profile cut out Stainless steel  
SS304 grade  
Supplied with suitable screws and fixings

**FINISHES**

SSS	Satin stainless steel
PSS	Polished stainless steel

\*Special finish available upon request subject to minimum order quantity

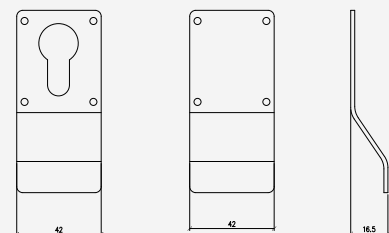
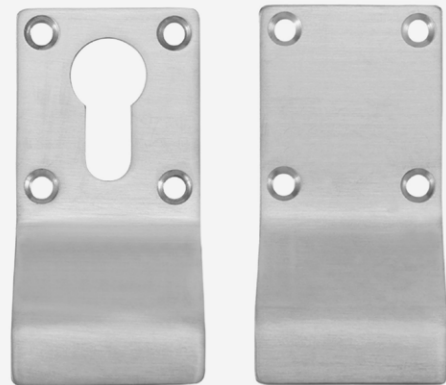

## DOOR HOOKS

Door hooks for different applications.

### PRODUCT CODE

- LIA8022 - Single Coat Hook
- LIA8023 - Double Coat and hat Hook
- LIA8024 - Single robe hook
- LIA8025 - Double robe hook
- LIA8026 - Double robe hook with Hat hook
- LIA8027 - Single hook with rose – concealed fix

### SPECIFICATION

Stainless steel SS304 grade  
Supplied with suitable screws and fixings

### FINISHES

SSS	Satin Stainless Steel
PSS	Polished Stainless Steel

\*Special finish available upon request subject to minimum order quantity

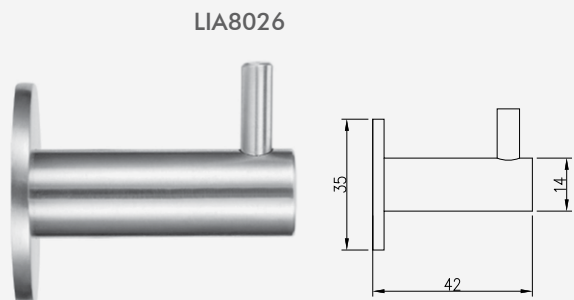
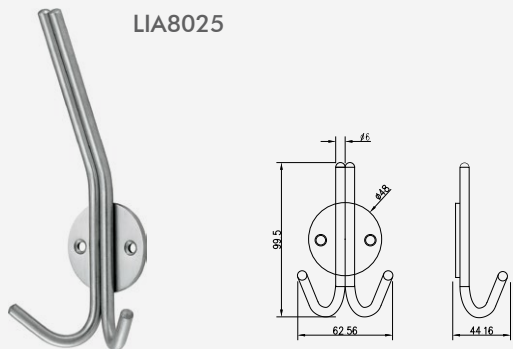
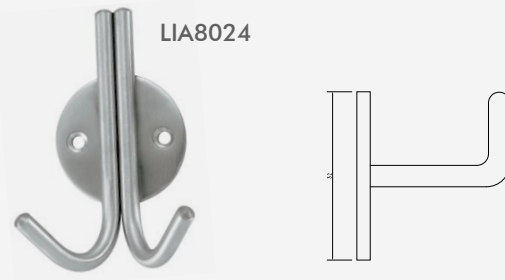
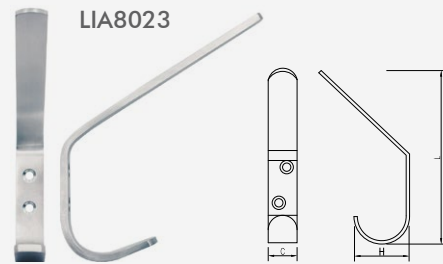

## FLUSH PULLS

Door flush pulls – Available in Rectangular/Oval/Circular and Square models

### PRODUCT CODE

- LIA8030 - Oval Flush pull
- LIA8031 - Rectangular Flush pull
- LIA8032 - Square Flush pull
- LIA8033 - Round Flush pull
- LIA8034 - Half moon Flush pull

### SPECIFICATION

Concealed fixing flush pulls  
Stainless steel SS304 grade  
Supplied with suitable screws and fixings

### FINISHES

SSS	Satin Stainless Steel
PSS	Polished Stainless Steel

\*Special finish available upon request subject to minimum order quantity

LIA8030

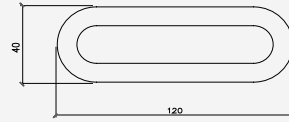

LIA8031

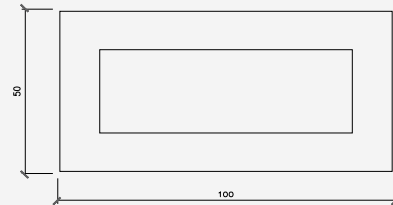

LIA8032

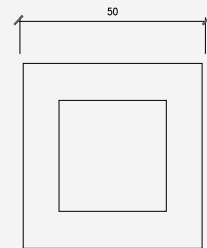
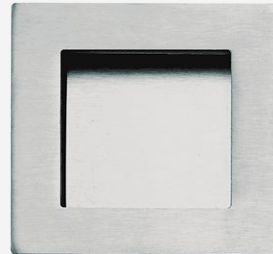

LIA8033

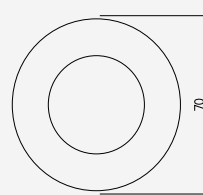

LIA8034

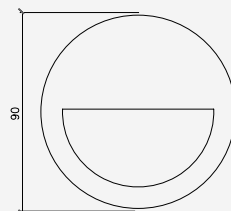

## RING PULL HANDLE

Ring Pull Handle – Face fixing

### PRODUCT CODE

LIA8035

### SPECIFICATION

Ring Pull handle – face fixing  
With 8mm square spindle  
Stainless steel SS304 grade  
Supplied with suitable screws and fixings

### FINISHES

SSS	Satin stainless steel
PSS	Polished stainless steel

\*Special finish available upon request subject to minimum order quantity

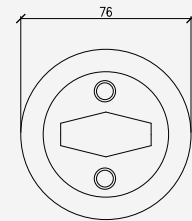

## LOCKS AND LATCHES

### PRODUCT CODE

LIA8036

### SPECIFICATION

Rack bolt lock supplied with hexagonal key and strike plates  
Supplied with suitable screws and fixings

### FINISHES

SSS	Satin stainless steel
PSS	Polished stainless steel

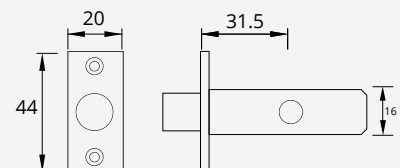

## LOCKS AND LATCHES

**PRODUCT CODE**

LIA8037

**SPECIFICATION**

Tubular latch lock with 8mm square follower supplied with lipped strike plate  
Supplied with suitable screws and fixings

**FINISHES**

SSS	Satin stainless steel
PSS	Polished stainless steel

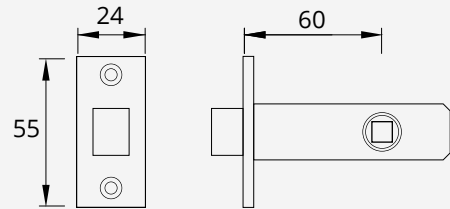
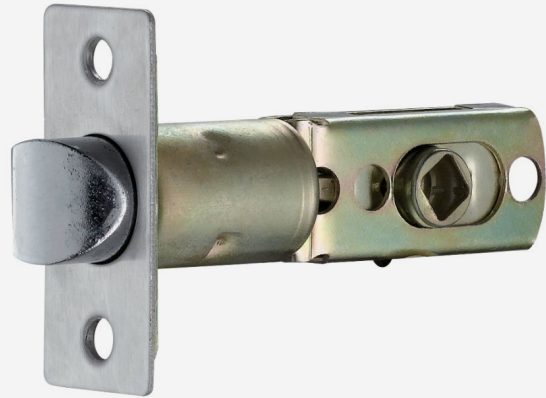

## LOCKS AND LATCHES

**PRODUCT CODE**

LIA8038

**SPECIFICATION**

Adjustable brass roller latch with SS strike plate  
Concealed adjustment  
Supplied with suitable screws and fixings

**FINISHES**

SSS	Satin stainless steel
PSS	Polished stainless steel

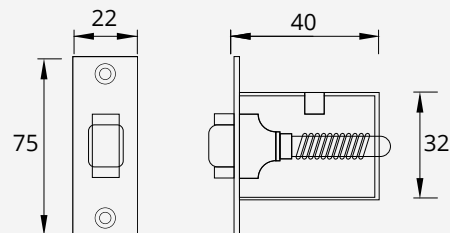
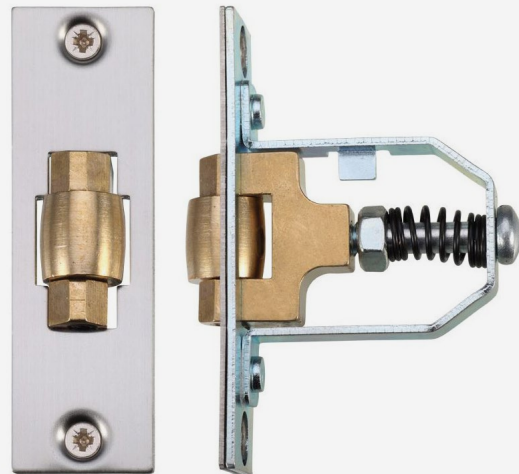

## SIGN PLATES

Sign plates – 76mm diameter – Face fixing

### PRODUCT CODE

LIA8039 - Male sex symbol

LIA8040 - Female sex symbol

LIA8041 - Disabled facilities symbol

LIA8042 - Baby change symbol

LIA8043 - Fire door keep shut symbol

### FINISHES

SSS	Satin Stainless Steel
PSS	Polished Stainless Steel

\*Special finish available upon request subject to minimum order quantity



**ACCESSORIES****DOOR VIEWER**

Door eye viewer with cover

**PRODUCT CODE**

LIA8044

**SPECIFICATION**

Door eye viewer with cover  
14mm dia suitable for 35-55mm door thickness 200  
degree angle of vision  
Available in different finishes  
Supplied with suitable screws and fixings

**FINISHES**

SC	Satin Chrome
PC	Polished Chrome
PB	Polished Brass

\*Special finish available upon request subject to minimum order quantity

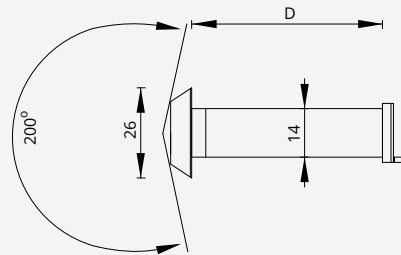

## FLUSH BOLTS

Lever action flush bolt for Wooden door application

### PRODUCT CODE

LIA8045

### AVAILABLE LENGTH

- 200mm
- 300mm
- 600mm
- 900mm

### SPECIFICATION

Lever action flush bolt for wooden door  
 With 20mm projecting bolt  
 Manufactured from Stainless steel SS304 grade  
 Available in various lengths  
 Solid model for length greater than 300mm Supplied with suitable screws and fixings

### FINISHES

SSS	Satin Stainless Steel
PSS	Polished Stainless Steel

\*Special finish available upon request subject to minimum order quantity

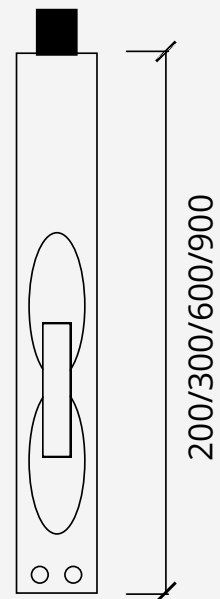

ACCESSORIES

**FLUSH BOLTS**

Lever action flush bolt for metal door application

**PRODUCT CODE**

LIA8046

**AVAILABLE LENGTH**

- 200mm
- 300mm
- 600mm
- 900mm

**SPECIFICATION**

Lever action flush bolt for metal door  
 With 20mm projecting bolt  
 Manufactured from Stainless steel SS304 grade  
 Available in various lengths  
 Supplied with suitable screws and fixings

**FINISHES**

SSS	Satin stainless steel
PSS	Polished stainless steel

\*Special finish available upon request subject to minimum order quantity

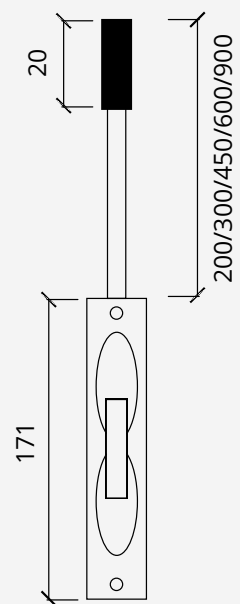

## DUST PROOF STRIKE

Dust proof strike to accept Lockron flush bolts

### PRODUCT CODE

LIA8047

### SPECIFICATION

Dust Proof strike for flush bolts  
38mm depth with concrete diameter 20mm Supplied with suitable screws and fixings

### FINISHES

SSS	Satin Stainless Steel
PSS	Polished Stainless Steel

\*Special finish available upon request subject to minimum order quantity

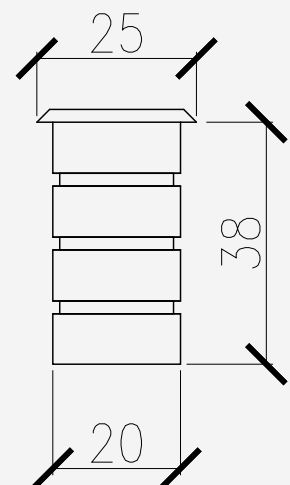

## TOWER BOLT

Lever action Tower Bolt

### PRODUCT CODE

LIA8048

### AVAILABLE LENGTH

200mm

300mm

600mm

900mm

### SPECIFICATION

Lever action Tower Bolt

Manufactured from Stainless steel SS304 grade

Available in various lengths

Supplied with suitable screws and fixings

### FINISHES

SSS	Satin stainless steel
PSS	Polished stainless steel

\*Special finish available upon request subject to minimum order quantity



## PULL PLATES

Pull plates with and without engraving

LIA8049 - With "PULL" engraved

LIA8050 - Without "PULL" engraved

PRODUCT CODE	DIMENSION
LIA8049-300	300 x 100 x 1.5mm
LIA8049-350	350 x 100 x 1.5mm
LIA8050-300	300 x 100 x 1.5mm
LIA8050-350	350 x 100 x 1.5mm

### SPECIFICATION

Heavy duty stainless steel SS304 grade pull plates Pencil bevelled on four sides standard  
Hole prepared for counter sunk screws  
Custom cut-out, sizes and shapes available Supplied with suitable screws and fixings

### FINISHES

SSS	Satin Stainless Steel
PSS	Polished Stainless Steel

\*Special finish available upon request subject to minimum order quantity

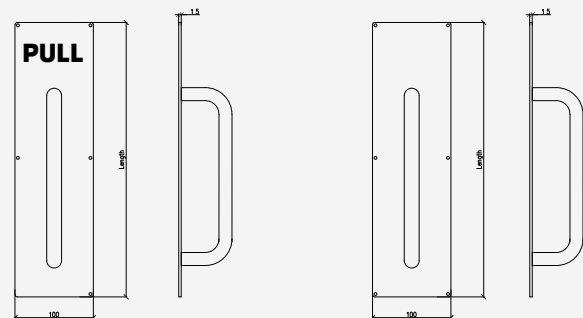
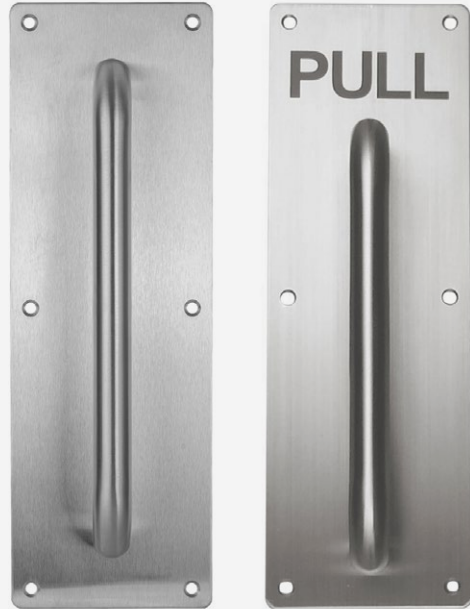

ACCESSORIES

DOOR HARDWARE

**PUSH PLATES**

Push plates with and without engraving

**PRODUCT CODE**

LIA8051 – With “PUSH” engraved  
LIA8052- Without “PUSH” engraved

**PRODUCT CODE**

**DIMENSION**

LIA8051-300	300 x 100 x 1.5mm
LIA8051-350	350 x 100 x 1.5mm
LIA8051-400	400 x 100 x 1.5mm
LIA8052-300	300 x 100 x 1.5mm
LIA8052-350	350 x 100 x 1.5mm
LIA8052-400	400 x 100 x 1.5mm

**SPECIFICATION**

Heavy duty stainless steel SS304 grade push plates  
Pencil bevelled on four sides standard  
Hole prepared for counter sunk screws Custom cut-out, sizes and shapes available Supplied with suitable screws and fixings

**FINISHES**

SSS	Satin stainless steel
PSS	Polished stainless steel

\*Special finish available upon request subject to minimum order quantity

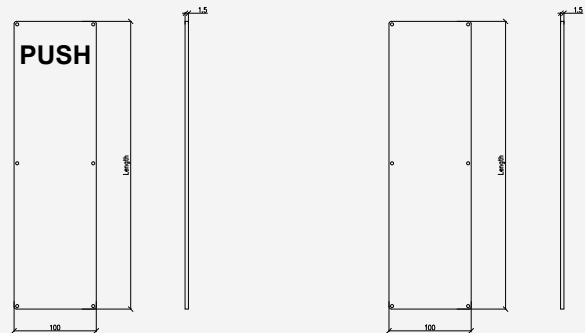
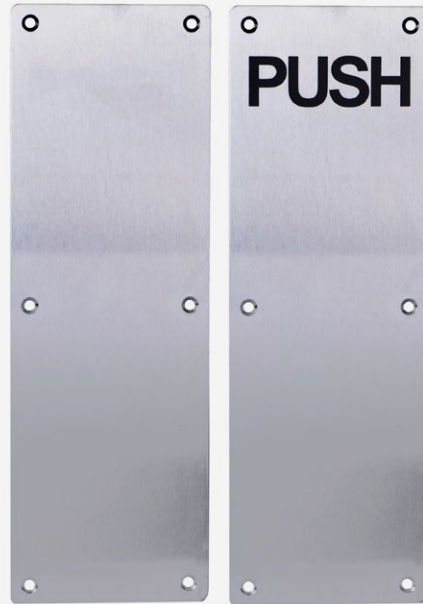

## ESCUTCHEONS

Slim Euro-profile escutcheon

### PRODUCT CODE

LIA8053 – Euro-profile round escutcheon

### SPECIFICATION

Escutcheons prepared to suit euro-profile cylinders  
Push on rose fixing with 4mm projection  
Manufactured from stainless steel SS304 grade  
Supplied with suitable screws and fixings

### FINISHES

SSS	Satin stainless steel
PSS	Polished stainless steel

\*Special finish available upon request subject to minimum order quantity

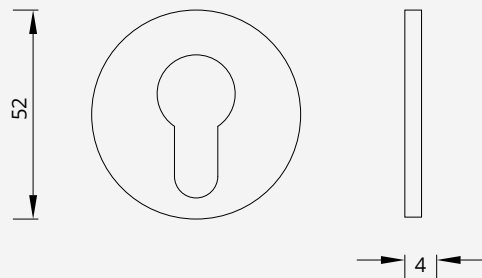

## AUTOMATIC FLUSH BOLTS

Automatic flush bolt for metal and wooden door application and Dust proof strike

### PRODUCT CODE

- LIA8054W- Wooden door application
- LIA8054M- Metal door application
- LIA8055- Dust proof strike

### FACEPLATE DIMENSIONS

- LIA8054W- 25.5mm x 216mm
- LIA8054M – 25mm x 171mm with standard rod length of 300mm

### SPECIFICATION

Non handed design automatic flush bolts for metal and wooden door application  
With fully automatic projecting bolt Manufactured from Stainless steel SS304 grade Supplied with suitable screws and fixings

### FINISHES

SSS	Satin stainless steel
PSS	Polished stainless steel

### DUST PROOF STRIKE SPECIFICATION

- Face Size: 3" x 1-1/2"
- Body Diameter: 15/16"
- Overall Length: 2-1/4"
- Supplied with suitable screws and fixings

### FINISHES

SCP	Satin chrome plated
-----	---------------------

\*Special finish available upon request subject to minimum order quantity

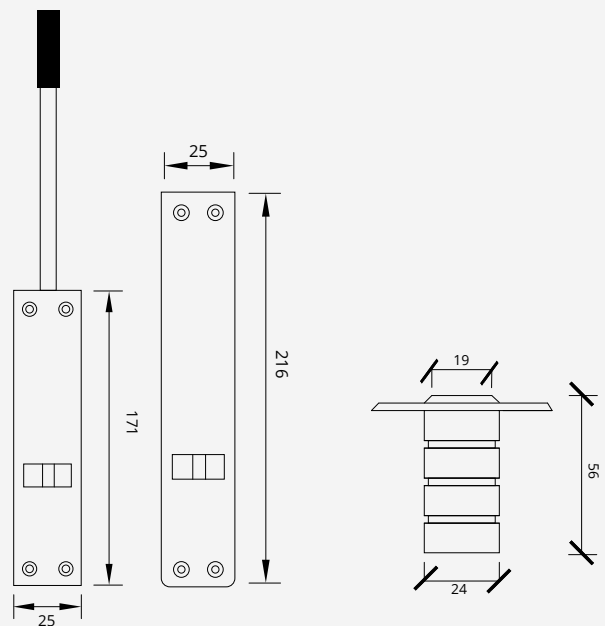

## DOOR STOPS

Door stop floor mounted - square collared flat top 35mm

### PRODUCT CODE

LIA8056

### SPECIFICATION

Floor mounted pedestal door stop Stainless steel  
SS304 grade  
35mm square  
30 x 40mm Overall size  
Supplied with suitable screws and fixings

### FINISHES

SSS	Satin stainless steel
PSS	Polished stainless steel

\*Special finish available upon request subject to minimum order quantity

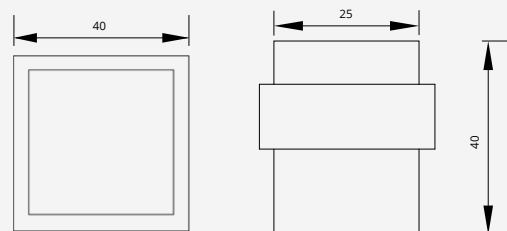
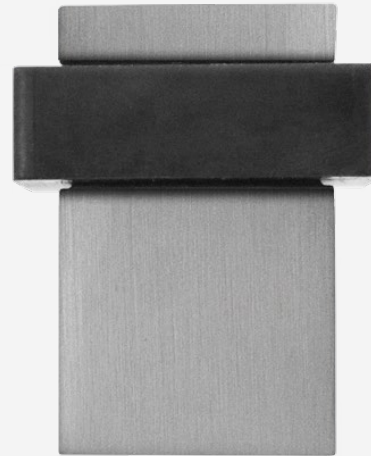

ACCESSORIES

DOOR HARDWARE

## SIGN PLATES

Sign plates – 100mm square – Face fixing

### PRODUCT CODE

LIA8057 – Male sex symbol square

LIA8058 – Female sex symbol square

LIA8059 – Disabled facilities symbol square

### FINISHES

SSS	Satin stainless steel
PSS	Polished stainless steel

\*Special finish available upon request subject to minimum order quantity

LIA8057



LIA8058



LIA8059



## WC INDICATORS

Toilet Turn & Emergency coin release with Indicator

### PRODUCT CODE

LIA8060

### SPECIFICATION

Toilet door indicator  
Thumb Turn & Emergency Release WC indicator  
Manufactured from Stainless steel SS304 grade  
Supplied with suitable screws and fixings

### FINISHES

SSS Satin stainless steel

\*Special finish available upon request subject to minimum order quantity

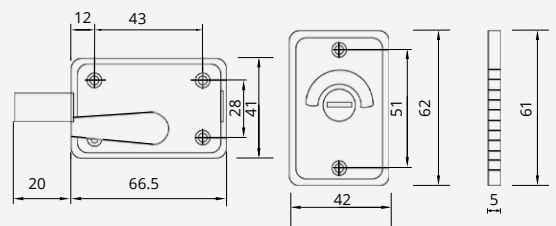

ACCESSORIES

DOOR HARDWARE

### EDGE PULL

Edge Pull for pocket sliding doors

**PRODUCT CODE**

LIA8061

**SIZE**

100mm x 20mm

**SPECIFICATION**

Edge Pull for pocket sliding doors

Stainless steel SS304 grade

Supplied with suitable screws and fixings

**FINISHES**

SSS Satin stainless steel

\*Special finish available upon request subject to minimum order quantity

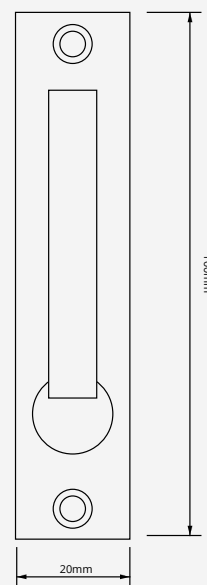

## FLUSH PULLS

Rectangular long Door flush pulls

### PRODUCT CODE

LIA8062 – Rectangular Flush pull

### SPECIFICATION

Concealed fixing flush pulls  
Stainless steel SS304 grade  
Supplied with suitable screws and fixings

### FINISHES

SSS	Satin stainless steel
PSS	Polished stainless steel

\*Special finish available upon request subject to minimum order quantity

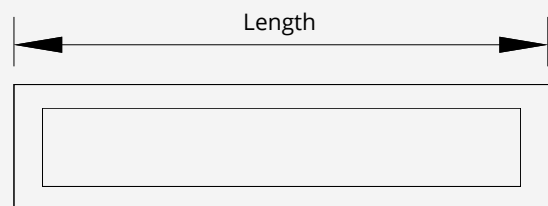

## BALL CATCH

Double ball catch

### PRODUCT CODE

LIA8063

### SIZE

70mm x 12.5mm

### SPECIFICATION

Double ball catch

Material: Brass

Supplied with suitable screws and fixings

### FINISHES

SSS	Satin stainless steel
PSS	Polished stainless steel

\*Special finish available upon request subject to minimum order quantity

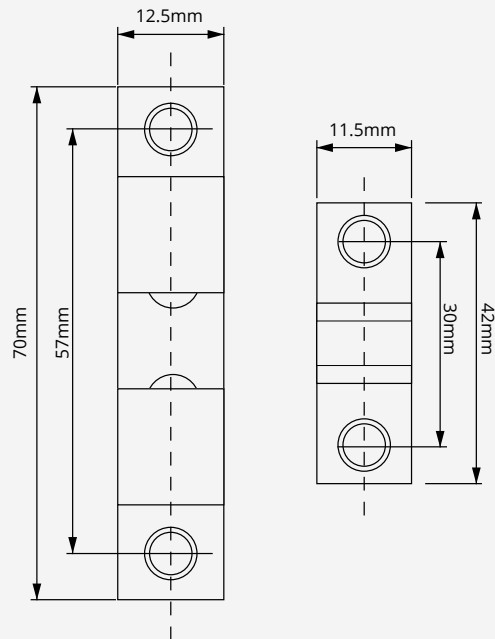
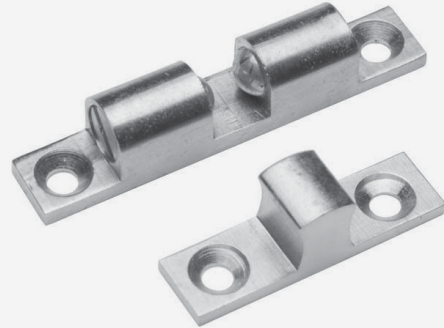

## DOOR HOLDER

Door mounted magnetic door holder

### PRODUCT CODE

LIA8064

### SPECIFICATION

Automatic projecting magnetic door holder  
Door mounted with concealed fixing screws  
Supplied with suitable screws and fixings

### FINISHES

SSS	Satin stainless steel
PSS	Polished stainless steel

\*Special finish available upon request subject to minimum order quantity

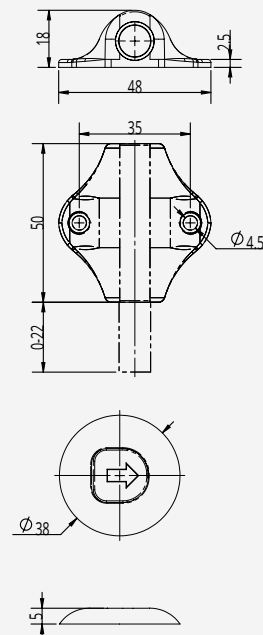

## DOOR STOPS

Door stop floor mounted – Square 32mm with locating pin

### PRODUCT CODE

LIA8065

### SPECIFICATION

Floor mounted square door stop Stainless steel SS304 grade 32mm x 32mm square  
With locating pin  
Supplied with suitable screws and fixings

### FINISHES

SSS	Satin stainless steel
PSS	Polished stainless steel

\*Special finish available upon request subject to minimum order quantity

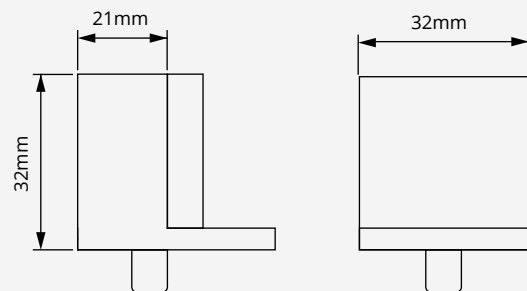

## DOOR STOPS

Door stop floor mounted – Square shape  
40x40mm

### PRODUCT CODE

LIA8066

### SPECIFICATION

Floor mounted Square door stop Stainless steel SS304  
grade Concealed fixing  
40 x 40mm Overall size  
Supplied with suitable screws and fixings

### FINISHES

SSS	Satin stainless steel
PSS	Polished stainless steel

\*Special finish available upon request subject to minimum order quantity

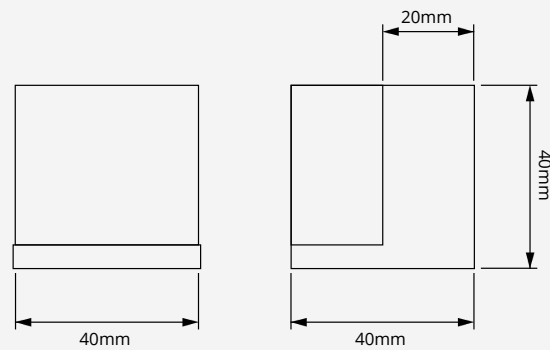

ACCESSORIES

DOOR HARDWARE

## DOOR HOLDER

Floor mounted door holder

### PRODUCT CODE

LIA8067

### SPECIFICATION

Floor mounted magnetic door holder Material : Zinc Alloy  
Supplied with suitable screws and fixings

### FINISHES

SNP	Satin Nickel Plated
PNP	Polished Nickel Plated

\*Special finish available upon request subject to minimum order quantity

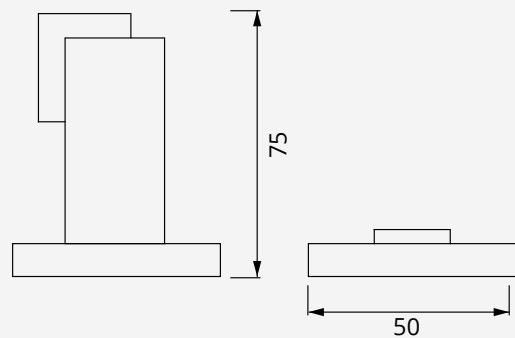

## WC INDICATORS

Thumb Turn & Emergency coin release with Indicator

### PRODUCT CODE

LIA8068

### SPECIFICATION

52mm diameter knurled design Thumb Turn & Emergency Release WC indicator  
 Supplied with 8mm Square spindle  
 Suitable up to 55mm door thickness  
 Manufactured from Stainless steel SS304 grade  
 Supplied with suitable screws and fixings

### FINISHES

SSS	Satin stainless steel
PSS	Polished stainless steel

\*Special finish available upon request subject to minimum order quantity

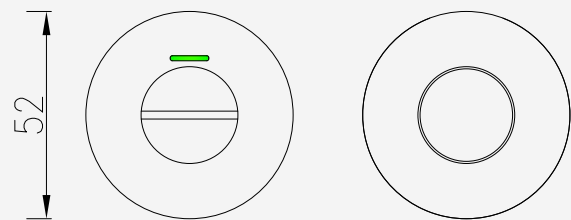

# FURNITURE FITTINGS





# CABINET HINGES

Lockron cabinet hinge series consists of concealed hinges with integrated soft close mechanism featuring various opening angles

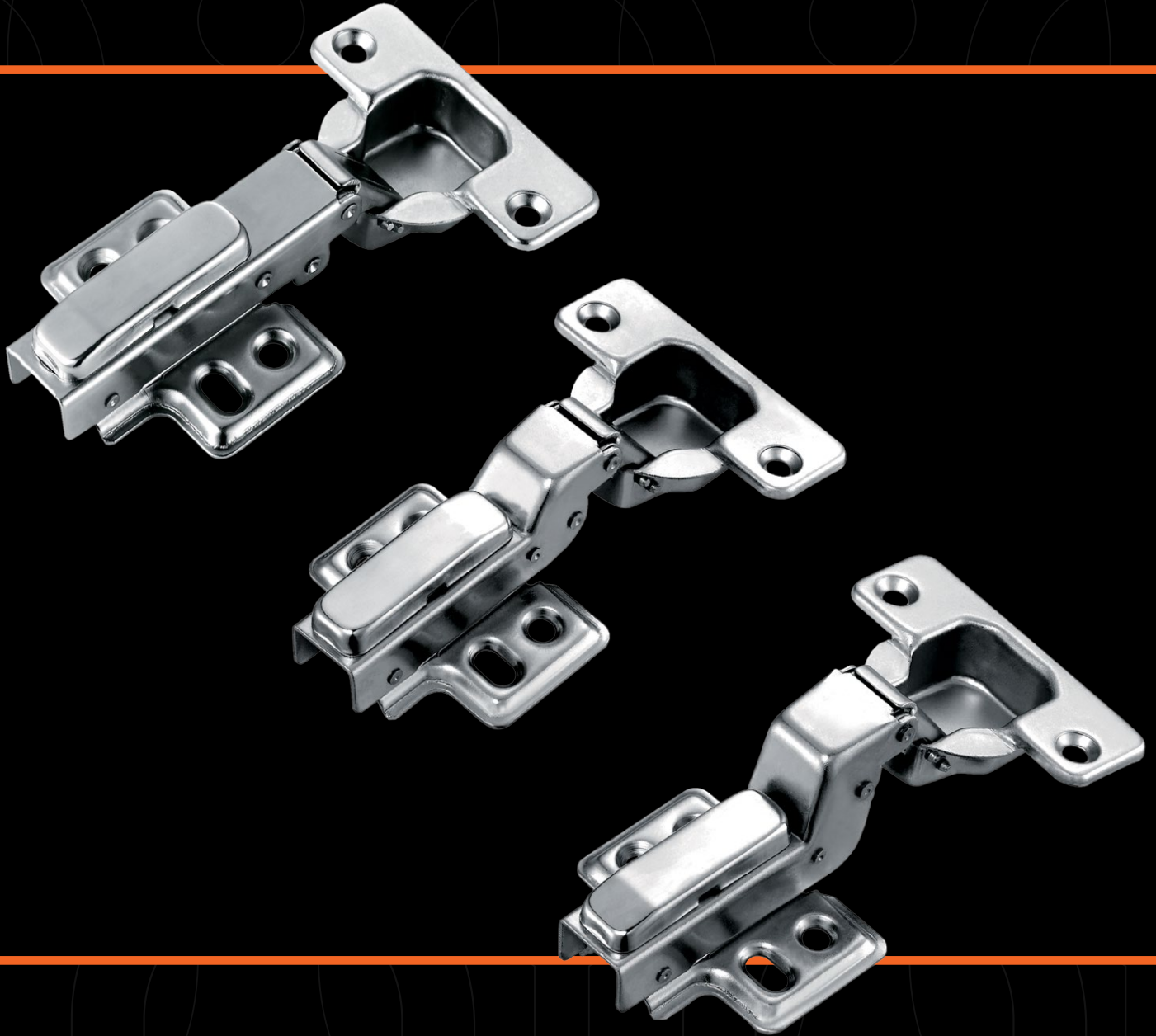

Featured Product

**LICH103**

## CONCEALED HINGES

Concealed Invisible hinges

### SPECIFICATION

- Drill in concealed hinges with zinc alloy body Stainless steel linkages
- Non-handed design
- Available in various sizes
- Supplied with suitable screws and fixings

### FINISHES

SCP	Satin Chrome plated
PC	Polished Chrome
SN	Satin Nickel
PB	Polished Brass
AB	Antique Bronze

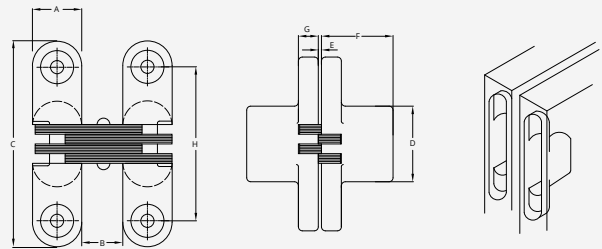

MODEL	A	B	C	D	E	F	G	H	Thickness & deviation of each connection
LICCH003	12.4	8.8	43.7	18.7	0.8	18.3	4.9	31.7	1.12±0.02
LICCH004	12.7	8.1	60.4	30	0.8	17.8	5.6	46	1.15±0.02
LICCH005	15.7	11.5	68.8	33.7	1.0	22.7	7.0	51.8	1.45±0.02
LICCH006	18.4	12.6	94	54.5	1.0	26.8	8.7	74	1.95±0.02
LICCH007	24.7	18.0	115.8	63.8	1.23	36.5	10.5	105	2.45±0.02

Dimensions are in mm

**CABINET HINGES**

FURNITURE FITTINGS

**HINGES**

Concealed Hinges for Cabinets

**PRODUCT CODE**

LICH101

**SPECIFICATION**

Type of installation: Slide on  
Suitable for door thickness 14-21mm  
Degree opening angle: 110°  
Diameter of cup: 35mm  
Depth of hinge cup: 11.3mm  
Material: Cold rolled steel  
Finish: Nickel Plated

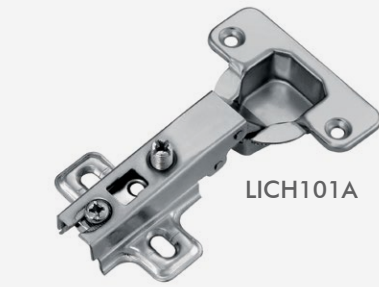
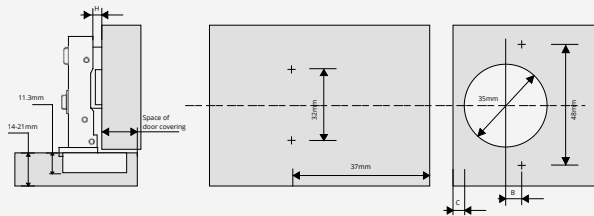

LICH101A



LICH101B



LICH101C

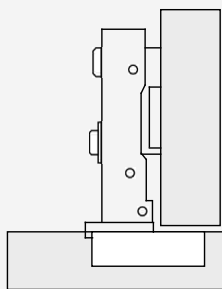

Full Overlay

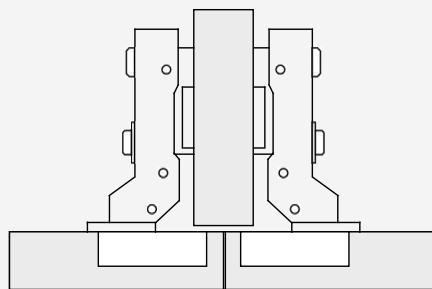

Half Overlay

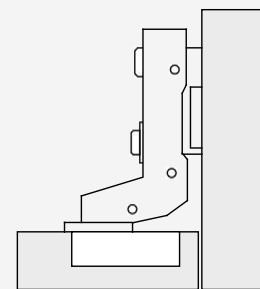

Inset

H	C	3	4	5	6	7
H=0	S	16	17	18	19	20
H=3	S	14	15	16	17	18

H	C	3	4	5	6	7
H=0	S	7	8	9	10	11
H=3	S	5	6	7	8	9

H	C	3	4	5	6	7
H=0	S	-2.5	-1.5	+0.5	0.5	1.5
H=3	S					

# HINGES

Concealed Hinges for Cabinets

## PRODUCT CODE

LICH102

## SPECIFICATION

- Built in Soft Closing feature
- Type of installation: Clip on
- Suitable for door thickness 14-21mm
- Degree opening angle: 110°
- Diameter of cup: 35mm
- Depth of hinge cup: 11.5mm
- Material: Cold rolled steel
- Finish: Nickel Plated

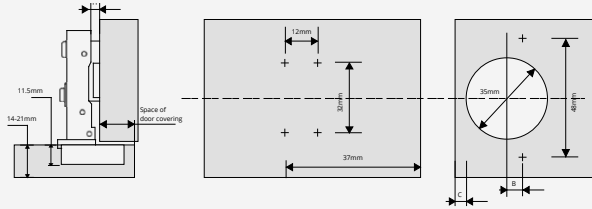

LICH102A



LICH102B



LICH102C

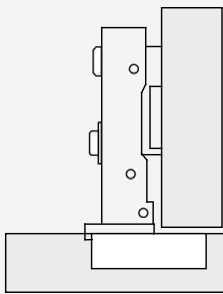

Full Overlay

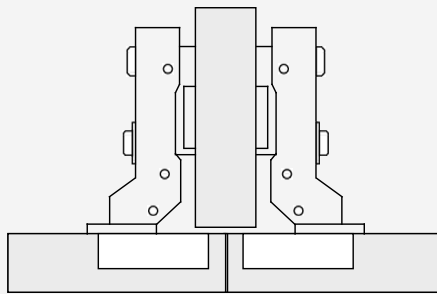

Half Overlay

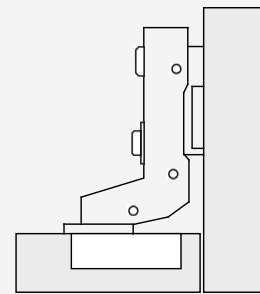

Inset

<b>H</b>	<b>C</b>	3	4	5	6	7
<b>S</b>						
<b>H=0</b>		16	17	18	19	20

<b>H</b>	<b>C</b>	3	4	5	6	7
<b>S</b>						
<b>H=0</b>		7	8	9	10	11

<b>H</b>	<b>C</b>	3	4	5	6	7
<b>S</b>						
<b>H=0</b>		-2.5	-1.5	+0.5	0.5	1.5

## HINGES

Concealed Hinges for Cabinets

### PRODUCT CODE

LICH103

### SPECIFICATION

- Built in Soft Closing feature
- Type of installation: Slide on
- Suitable for door thickness 14-21mm
- Degree opening angle: 110°
- Diameter of cup: 35mm
- Depth of hinge cup: 11.5mm
- Material: Cold rolled steel
- Finish: Nickel Plated



LICH103A



LICH103B



LICH103C

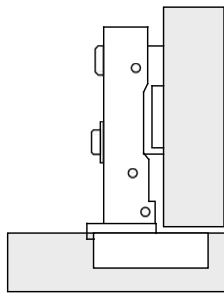
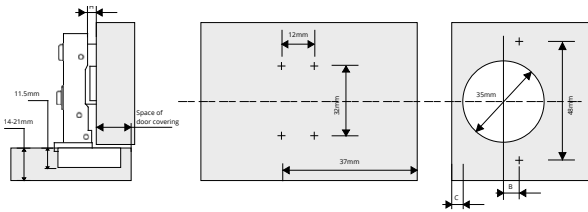

Full Overlay

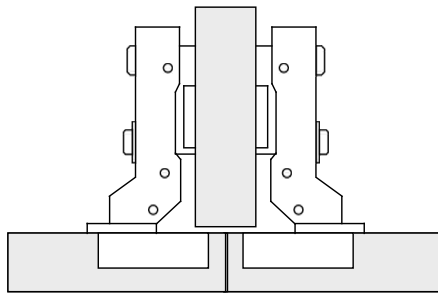

Half Overlay

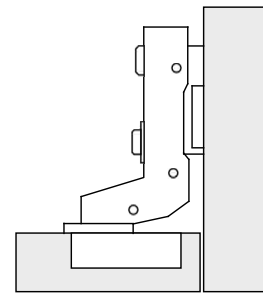

Inset

H	C	3	4	5	6	7
S						
H=0		16	17	18	19	20

H	C	3	4	5	6	7
S						
H=0		7	8	9	10	11

H	C	3	4	5	6	7
S						
H=0		-2.5	-1.5	+0.5	0.5	1.5

# HINGES

Concealed Hinges for Cabinets

## PRODUCT CODE

LICH165

## SPECIFICATION

- Built in Soft Closing feature
- Type of installation: Slide on
- Suitable for door thickness 14-21mm
- Degree opening angle: 165°
- Diameter of cup: 35mm
- Depth of hinge cup: 11.5mm
- Material: Cold rolled steel
- Finish: Nickel Plated



LICH165A



LICH165B



LICH165C

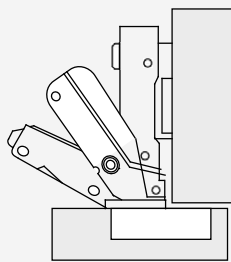
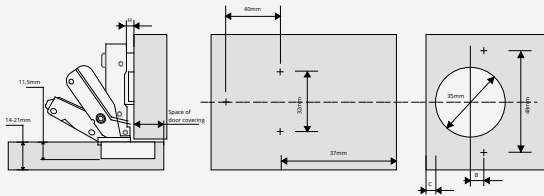

Full Overlay

H	S	C				
		3	4	5	6	7
H=0		16	17	18	19	20
H=3		13	14	15	16	17
H=5		10	11	12	13	14

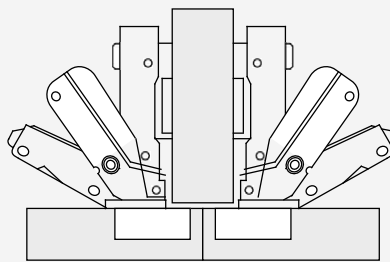

Half Overlay

H	S	C				
		3	4	5	6	7
H=0		7	8	9	10	11
H=3		4	5	6	7	8
H=5		1	2	3	4	5

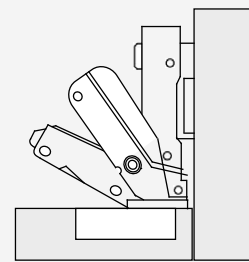

Inset

H	S	C				
		3	4	5	6	7
H=0		-2.5	-1.5	+0.5	0.5	1.5



# DRAWER RUNNERS

Lockron drawer runners series consists of undermount and side mount options with push-to-open and soft close mechanism



Featured Product

**LIDRSS350**

## DRAWER RUNNER

Undermount drawer runners with push to open mechanism

### PRODUCT CODE - HOW TO ORDER

LIDRUP270

300	300mm drawer length
350	350mm drawer length
400	400mm drawer length
450	450mm drawer length
500	500mm drawer length
550	550mm drawer length

Example: LIDRUP270 for drawer length 270mm

### SPECIFICATION

- Full extension with push to open mechanism
- Integrated silent system
- Tool-less Drawer height adjustment: 0~+3mm Load
- Capacity : 30kg
- Lengths available from 270mm to 550mm
- Finish: Zinc Plated

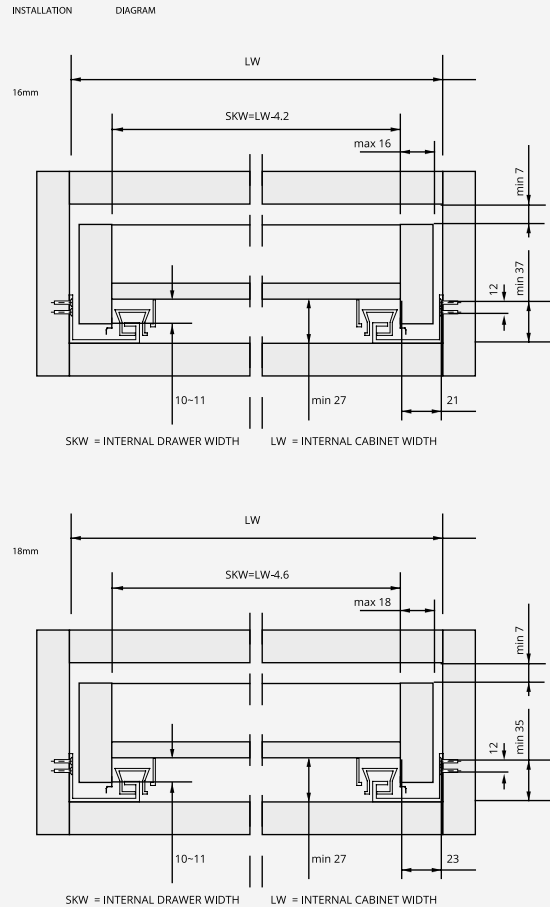
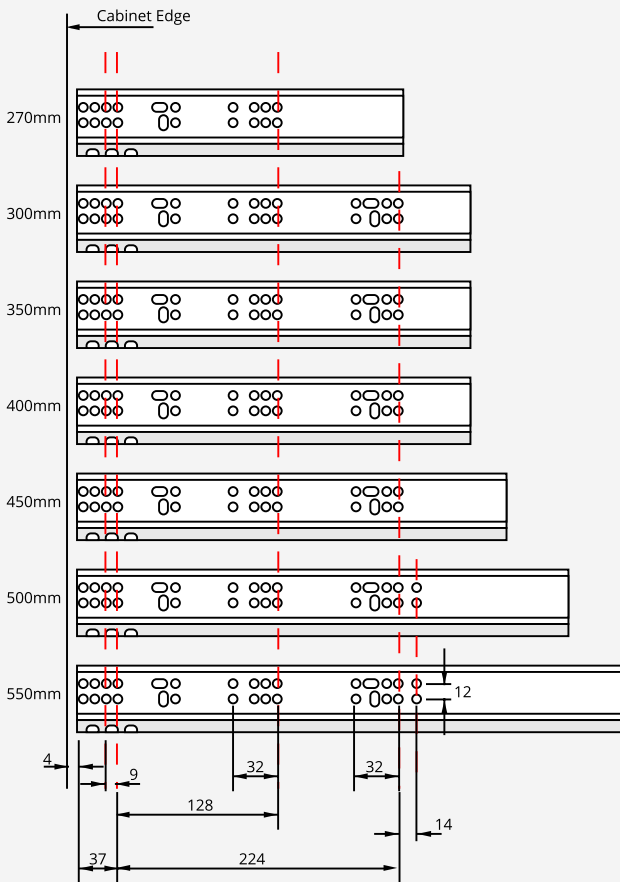

## DRAWER RUNNER

Undermount drawer runners with soft closing mechanism

### PRODUCT CODE - HOW TO ORDER

**LIDRUS270**

300	300mm drawer length
350	350mm drawer length
400	400mm drawer length
450	450mm drawer length
500	500mm drawer length
550	550mm drawer length

Example: LIDRUS270 for drawer length 270mm

### SPECIFICATION

- Full extension with soft closing mechanism
- Integrated silent system
- Tool-less Drawer height adjustment: 0~+3mm Load
- Capacity : 30kg
- Lengths available from 270mm to 550mm
- Finish: Zinc Plated

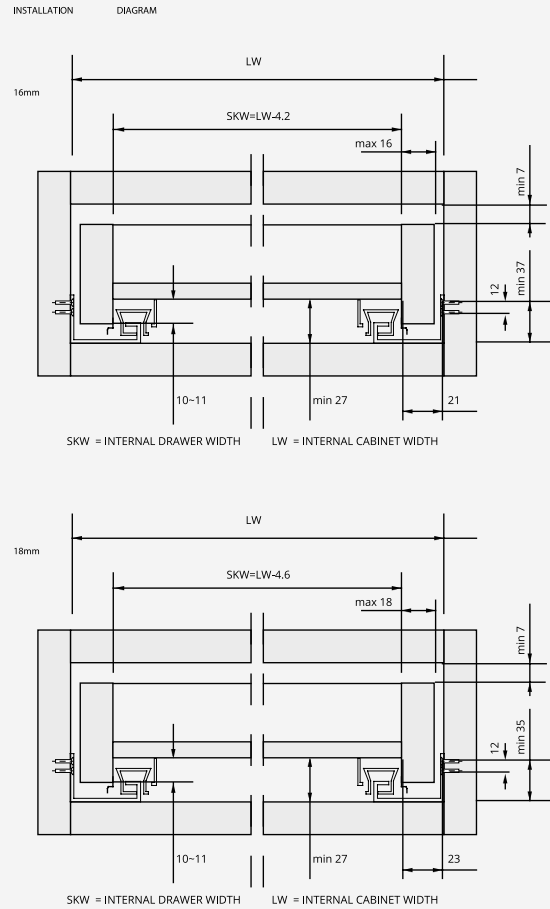
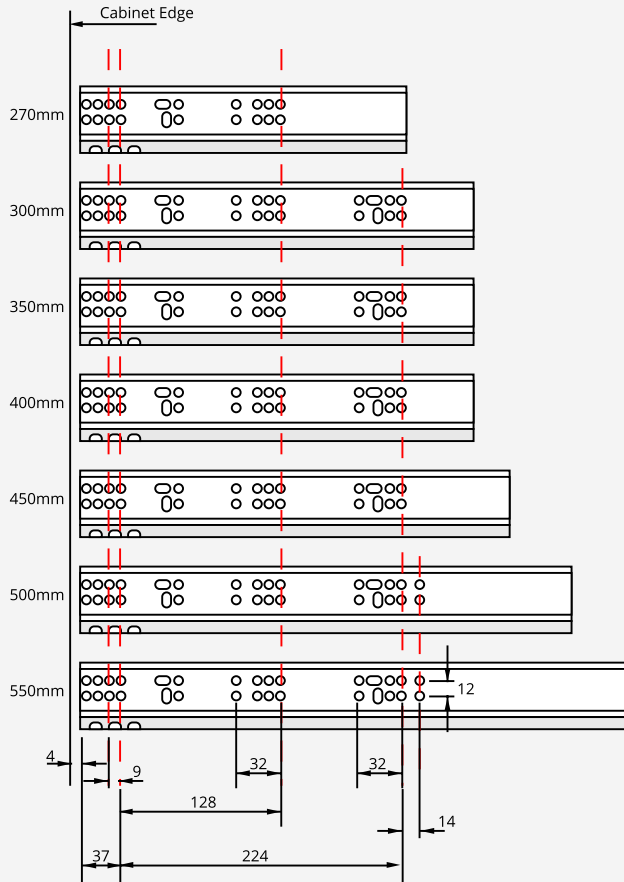

## DRAWER RUNNER

Side-mount 45mm ball bearing drawer runners with push to open mechanism

### PRODUCT CODE - HOW TO ORDER

**LIDRSP250**

300	300mm drawer length
350	350mm drawer length
400	400mm drawer length
450	450mm drawer length
500	500mm drawer length
550	550mm drawer length
600	600mm drawer length

Example: LIDRSP250 for drawer length 250mm

### SPECIFICATION

- Full extension with push to open mechanism
- High lateral stability with silent operation
- Load Capacity: 35kg
- Material : Cold Rolled Steel
- Lengths available from 250mm to 600mm
- Finish: Zinc Plated + electrophoresis

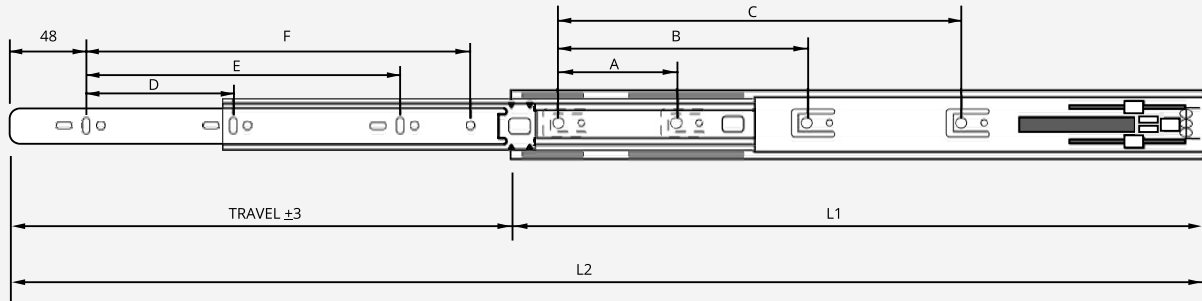
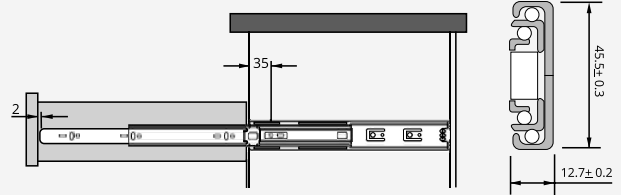

LENGTH	L1	L2	Travel	A	B	C	D	E	F
250	250	475	225	/	/	/	/	/	130.4
300	300	600	300	64	/	/	96	/	180.4
350	350	700	350	64	128	/	96	224	/
400	400	800	400	64	192	/	128	271	/
450	450	900	450	64	160	224	160	320	/
500	500	1000	500	64	160	256	160	352	/
550	550	1100	550	64	192	288	192	420	/
600	600	1200	600	64	256	320	224	448	/

## DRAWER RUNNER

Side-mount 45mm ball bearing drawer runners with soft closing mechanism

### PRODUCT CODE - HOW TO ORDER

**LIDRSS250**

300	300mm drawer length
350	350mm drawer length
400	400mm drawer length
450	450mm drawer length
500	500mm drawer length
550	550mm drawer length

Example: LIDRSS250 for drawer length 250mm

### SPECIFICATION

Full extension with soft closing mechanism  
 High lateral stability with silent operation  
 Load Capacity : 35kg  
 Material : Cold Rolled Steel  
 Lengths available from 250mm to 600mm  
 Finish: Zinc Plated + electrophoresis

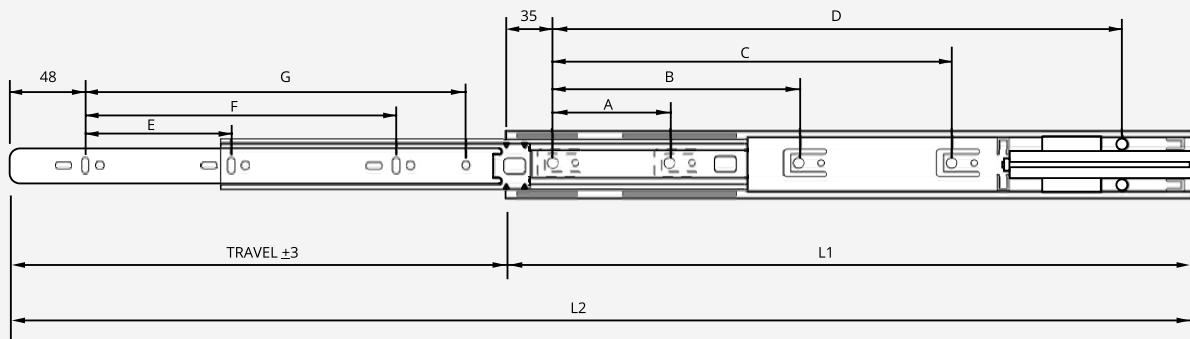
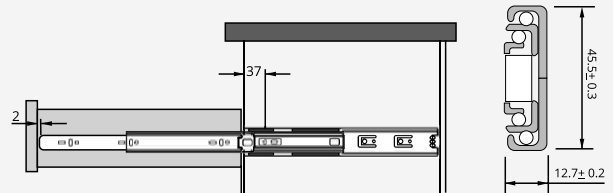

LENGTH	L1	L2	Travel	A	B	C	D	E	F	G
250	250	453	203	/	/	/	175	/	/	113.6
300	300	583	283	64	/	/	225	64	/	163.6
350	350	697	347	64	128	/	275	96	/	213.6
400	400	800	400	64	160	/	325	160	/	263.6
450	450	900	450	64	160	224	375	160	/	313.6
500	500	1000	500	64	192	256	425	192	/	363.6
550	550	1100	550	64	224	320	475	192	352	413.6
600	600	1200	600	64	256	384	525	224	384	463.6

## CABINET HANDLES & KNOBS

Lockron cabinet handles and knob series are made exclusively from 304 grade stainless steel with few designer handles made from zinc alloy



Featured Product

**LIFH118**  
**LIFH122**

**PRODUCT CODE**

Code	Dia	C	L
LIFH101A	10	96	150
LIFH101B	10	128	200
LIFH101C	10	160	250
LIFH101D	10	192	300
LIFH101E	10	224	350
LIFH101F	10	256	400
LIFH101G	10	288	450
LIFH101H	10	320	500

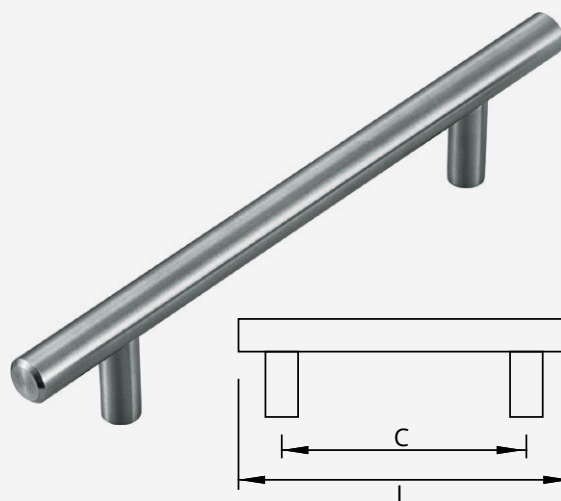

**PRODUCT CODE**

Code	Dia	C
LIFH102A	10	96
LIFH102B	10	128
LIFH102C	10	160
LIFH102D	10	192
LIFH102E	10	224
LIFH102F	10	256
LIFH102G	10	288
LIFH102H	10	320



**PRODUCT CODE**

Code	Dia	C
LIFH103A	10	96
LIFH103B	10	128
LIFH103C	10	160
LIFH103D	10	192
LIFH103E	10	224
LIFH103F	10	256
LIFH103G	10	288
LIFH103H	10	320
LIFH103I	10	352
LIFH103J	10	480



**CABINET HANDLES**

FURNITURE FITTINGS

**PRODUCT CODE**

Code	Dia	C
LIFH104A	10	96
LIFH104B	10	128
LIFH104C	10	160
LIFH104D	10	192
LIFH104E	10	224
LIFH104F	10	256
LIFH104G	10	288
LIFH104H	10	320
LIFH104I	10	352
LIFH104J	10	480

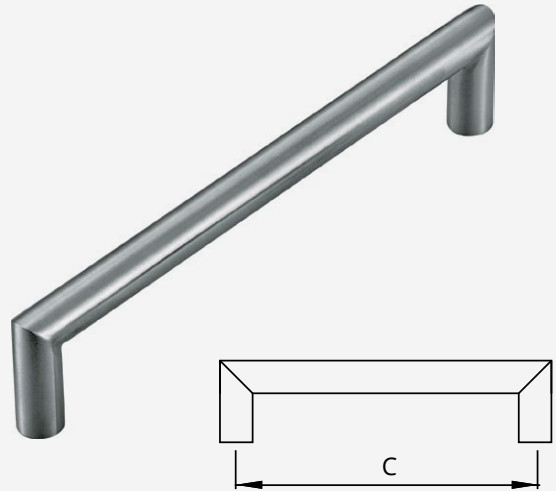

**PRODUCT CODE**

Code	Dia	C
LIFH105A	10	96
LIFH105B	10	128
LIFH105C	10	160
LIFH105D	10	192
LIFH105E	10	224
LIFH105F	10	256
LIFH105G	10	288
LIFH105H	10	320
LIFH105I	10	352
LIFH105J	10	480

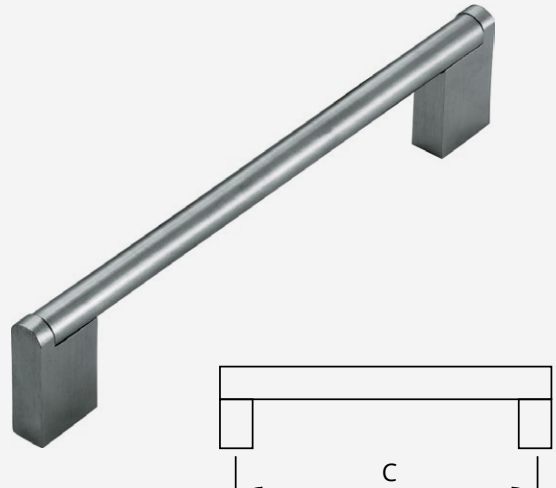

**PRODUCT CODE**

Code	SQ	C
LIFH106A	12	96
LIFH106B	12	128
LIFH106C	12	160
LIFH106D	12	192
LIFH106E	12	224
LIFH106F	12	256
LIFH106G	12	288
LIFH106H	12	320
LIFH106I	12	352
LIFH106J	12	480

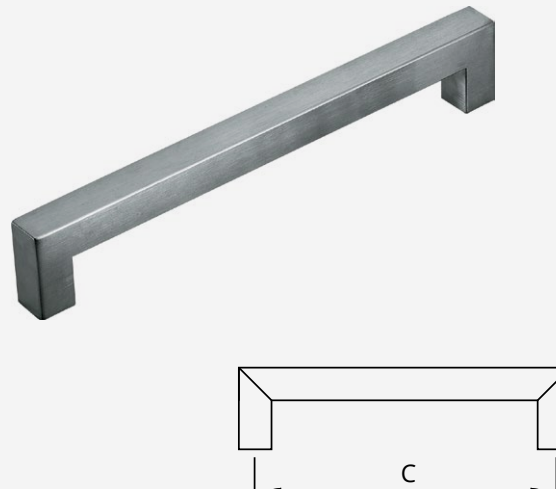

**PRODUCT CODE**

Code	Dia	C
LIFH107A	12	96
LIFH107B	12	128
LIFH107C	12	160
LIFH107D	12	192
LIFH107E	12	224
LIFH107F	12	256
LIFH107G	12	288
LIFH107H	12	320
LIFH107I	12	352
LIFH107J	12	480

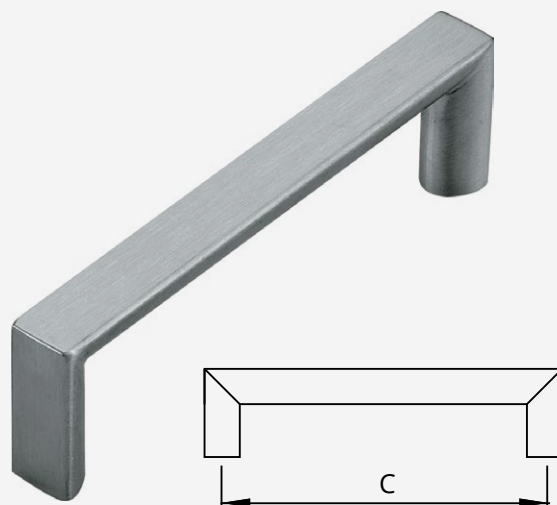

**PRODUCT CODE**

Code	SQ	C
LIFH108A	10	96
LIFH108B	10	128
LIFH108C	10	160
LIFH108D	10	192
LIFH108E	10	224
LIFH108F	10	256
LIFH108G	10	288
LIFH108H	10	320
LIFH108I	10	352
LIFH108J	10	480

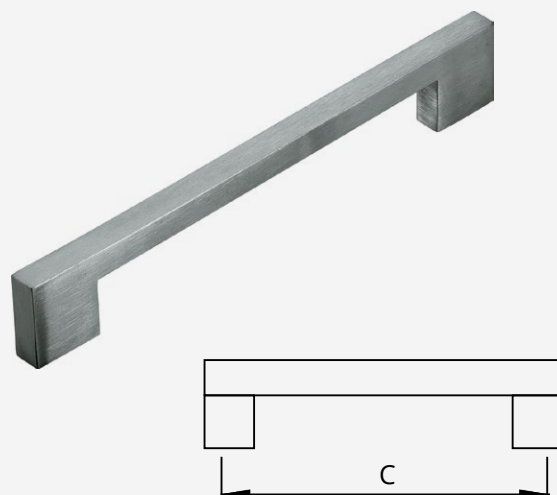

**PRODUCT CODE**

Code	RCT	C
LIFH109A	6x25	96
LIFH109B	6x25	128
LIFH109C	6x25	160
LIFH109D	6x25	192
LIFH109E	6x25	224
LIFH109F	6x25	256
LIFH109G	6x25	288
LIFH109H	6x25	320
LIFH109I	6x25	352
LIFH109J	6x25	480

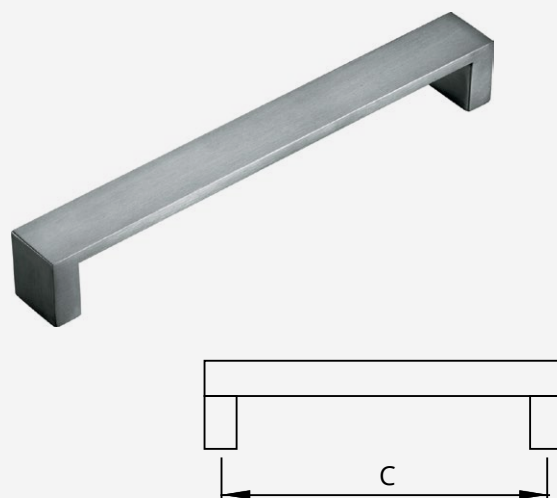

**CABINET HANDLES**

FURNITURE FITTINGS

**PRODUCT CODE**

Code	RCT	C
LIFH110A	6x12	96
LIFH110B	6x12	128
LIFH110C	6x12	160
LIFH110D	6x12	192
LIFH110E	6x12	224
LIFH110F	6x12	256
LIFH110G	6x12	288
LIFH110H	6x12	320
LIFH110I	6x12	352
LIFH110J	6x12	480

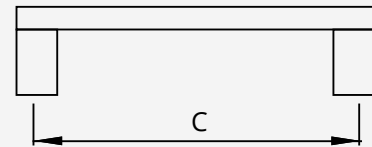

**PRODUCT CODE**

Code	SQ	C	L
LIFH111A	12	96	156
LIFH111B	12	128	188
LIFH111C	12	160	220
LIFH111D	12	192	252
LIFH111E	12	224	284
LIFH111F	12	256	316
LIFH111G	12	288	348
LIFH111H	12	320	380
LIFH111I	12	352	412
LIFH111J	12	480	540

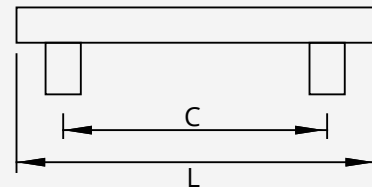

**PRODUCT CODE**

Code	Size	C
LIFH112A	6x12	96
LIFH112B	6x12	128
LIFH112C	6x12	160
LIFH112D	6x12	192
LIFH112E	6x12	224
LIFH112F	6x12	256
LIFH112G	6x12	288
LIFH112H	6x12	320
LIFH112I	6x12	352
LIFH112J	6x12	480

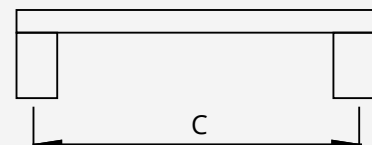
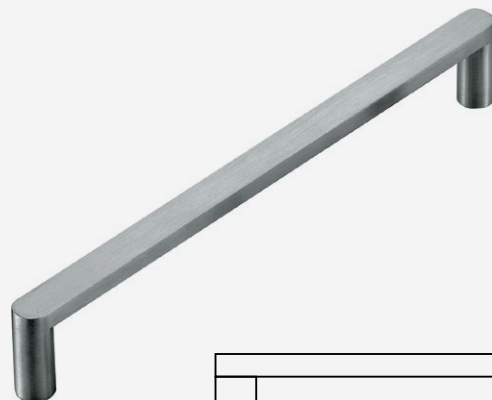

**PRODUCT CODE**

Code	SQ	C
LIFH113A	12	96
LIFH113B	12	128
LIFH113C	12	160
LIFH113D	12	192
LIFH113E	12	224
LIFH113F	12	256
LIFH113G	12	288
LIFH113H	12	320
LIFH113I	12	352
LIFH113J	12	480

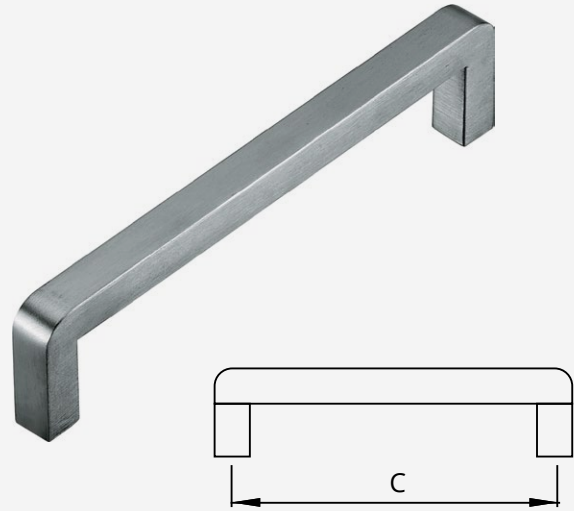

**PRODUCT CODE**

Code	DIA	C
LIFH114A	10	96
LIFH114B	10	128
LIFH114C	10	160

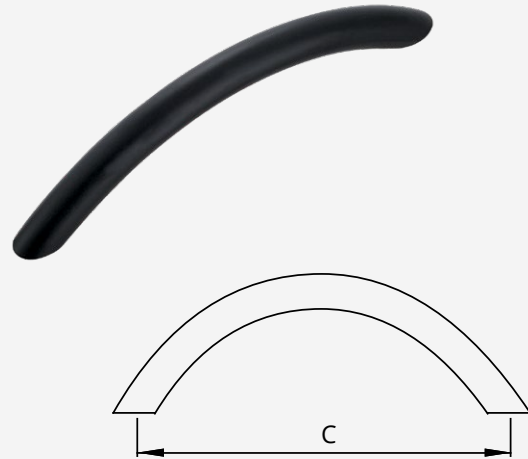

**PRODUCT CODE**

Code	DIA	C
LIFH115A	11	96
LIFH115B	13	128

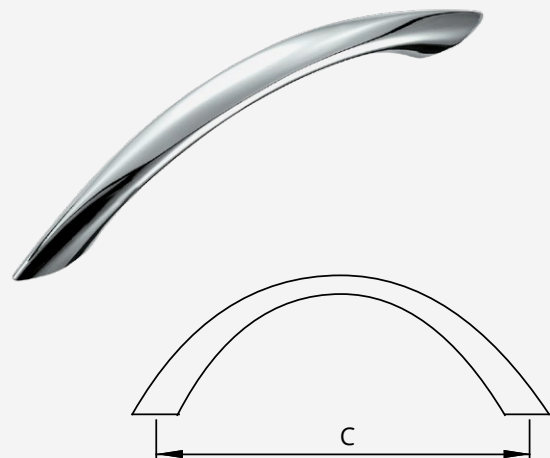

PRODUCT CODE

Code	C
LIFH116A	96
LIFH116B	128
LIFH116C	160

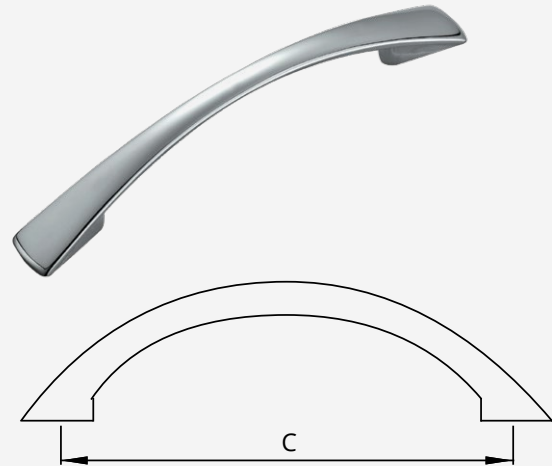

PRODUCT CODE

Code	L
LIFH117A	96
LIFH117B	128
LIFH117C	160

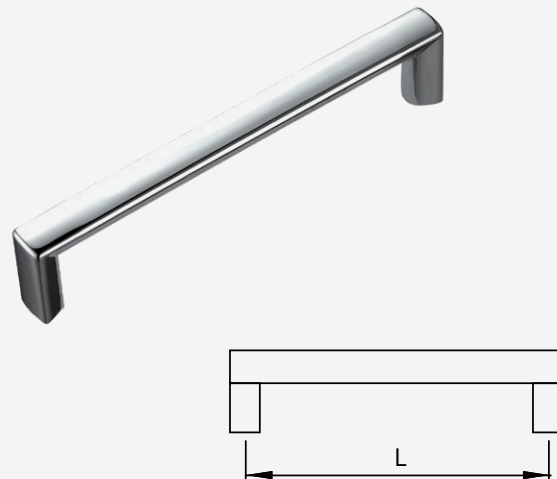

PRODUCT CODE

Code	C	L
LIFH118A	96	156
LIFH118B	128	188
LIFH118C	160	220

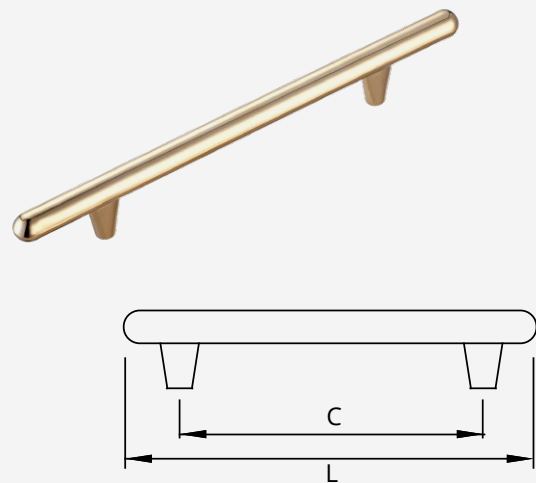

**PRODUCT CODE**

Code	C
LIFH119A	96
LIFH119B	128
LIFH119C	160

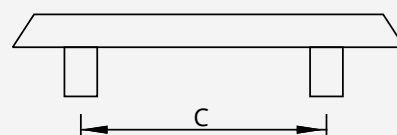
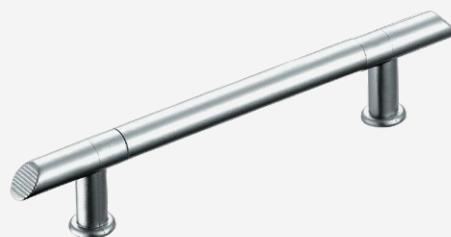

**PRODUCT CODE**

Code	C	L
LIFH120A	96	156
LIFH120B	128	188
LIFH120C	160	220

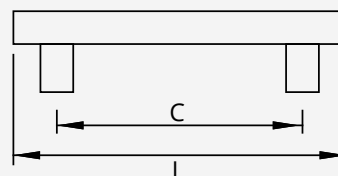

**PRODUCT CODE**

Code	L
LIFH121A	96
LIFH121B	128
LIFH121C	160

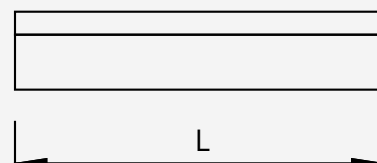

**PRODUCT CODE**

Code	C
LIFH122A	96
LIFH122B	128
LIFH122C	160

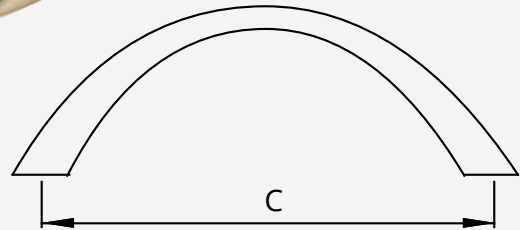

**PRODUCT CODE**

Code	C
LIFH123A	96
LIFH123B	128
LIFH123C	160

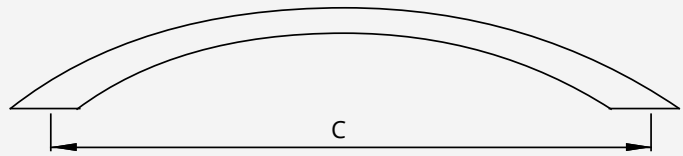

**PRODUCT CODE**

Code	C	L
LIFH124A	96	156
LIFH124B	128	188
LIFH124C	160	220

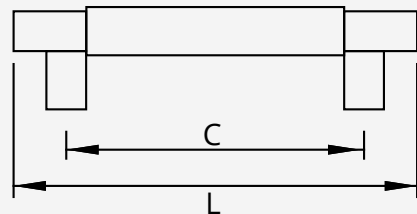

**PRODUCT CODE**

Code	C	L
LIFH125A	64	76
LIFH125B	64	100

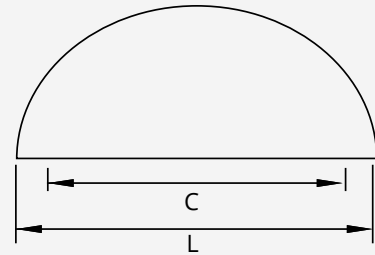

**CABINET KNOBS**

FURNITURE FITTINGS

**Product Code**  
LIFK001

**Size:** 30Ø x 24



**Product Code**  
LIFK002

**Size:** 20Ø x 32



**Product Code**  
LIFK003

**Size:** 25Ø x 28



**Product Code**  
LIFK004

**Size:** 25Ø x 25



**Product Code**  
LIFK005

**Size:** 20Ø x 28



**Product Code**  
LIFK006

**Size:** 20Ø x 20



**CABINET KNOBS**

FURNITURE FITTINGS

**Product Code**  
LIFK007

**Size:** 25Ø x 25



**Product Code**  
LIFK008

**Size:** 25Ø x 35



**Product Code**  
LIFK009

**Size:** 20Ø x 25



**Product Code**  
LIFK010

**Size:** 25Ø x 28



**Product Code**  
LIFK011

**Size:** 30Ø x 24



**Product Code**  
LIFK012

**Size:** 20Ø x 35

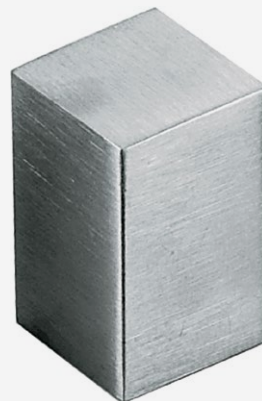

**CABINET KNOBS**

FURNITURE FITTINGS

**Product Code**  
LIFK013

**Size:** 25Ø x 25



**Product Code**  
LIFK014

**Size:** 25Ø x 28



**Product Code**  
LIFK015

**Size:** 20Ø x 32



**Product Code**  
LIFK016

**Size:** 50 x 32 x 12Ø



**Product Code**  
LIFK017

**Size:** 25Ø x 28



**Product Code**  
LIFK018

**Size:** 25Ø x 19



**Product Code**  
LIFK019

**Size:** 50mm x 32mm x Ø 12mm



**Product Code**  
LIFK020

**Size:** 29mm x Ø 32mm



**Product Code**  
LIFK021

**Size:** 32mm x Ø 19mm



## CABINET ACCESSORIES

Lockron cabinet accessories includes push to open mechanism, soft close mechanism, shelf support, wardrobe rail, flap stay, cabinet locks, magnetic catches and more



Featured Product

**LICFA9013**

**Product Code**  
LICFA9001

**SPECIFICATION**

Push to open mechanism – Surface fixing  
Finish: Grey



**Product Code**  
LICFA9002

**SPECIFICATION**

Push to open mechanism – Concealed fixing  
Finish: Grey



**Product Code**  
LICFA9003

**SPECIFICATION**

Push to open mechanism – Drill in  
Finish: Grey



**Product Code**  
LICFA9004

**SPECIFICATION**

Soft close mechanism – Drill in  
**Finish: Grey**



**Product Code**  
LICFA9005

**SPECIFICATION**

Shelf support  
**Finish: Nickel**



**Product Code**  
LICFA9006

**SPECIFICATION**

Wardrobe rail centre support  
**Finish: Chrome**



**Product Code**  
LICFA9007

**SPECIFICATION**

Wardrobe rail support for Oval Tube  
**Finish: Nickel**



**Product Code**  
LICFA9008

**SPECIFICATION**

Wardrobe rail support for Round Tube  
**Finish: Nickel**



**Product Code**  
LICFA9009

**SPECIFICATION**

Wardrobe rail Oval  
**Size: 3000 X 15 X 0.8mm**  
**Finish: Chrome**



**Product Code**  
LICFA9010

**SPECIFICATION**

Wardrobe rail Round  
Size: 3000 X 25 X 0.8mm  
Finish: Chrome



**Product Code**  
LICFA9011

**SPECIFICATION**

Cabinet suspension bracket Load  
Capacity 50kg per pair  
Finish: White



**Product Code**  
LICFA9012

**SPECIFICATION**

Flap stay – 100N  
Finish: Silver grey



**Product Code**  
LICFA9013

**SPECIFICATION**  
Flap stay  
**Finish:** Satin Nickel



**Product Code**  
LICFA9014

**SPECIFICATION**  
Push latch  
**Finish:** Chrome

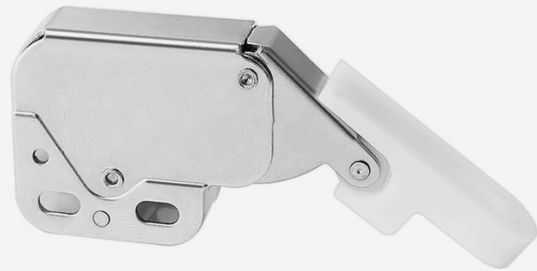

**Product Code**  
LICFA9015

**SPECIFICATION**  
Ball catch  
**Finish:** Polished brass

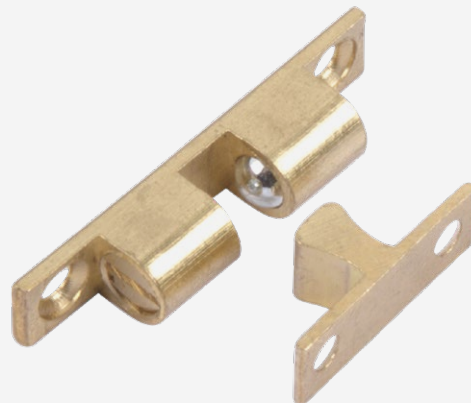

**Product Code**  
LICFA9016

**SPECIFICATION**

Magnetic catch - Single  
**Finish:** White/Brown/Black



**Product Code**  
LICFA9017

**SPECIFICATION**

Magnetic catch - Double  
**Finish:** White



**Product Code**  
LICFA9018

**SPECIFICATION**

Magnetic Push catch for glass door  
**Finish:** Black



**Product Code**  
LICFA9019

**SPECIFICATION**

Push to open door catch  
Size: 38X36.5X15mm  
Finish: White



**Product Code**  
LICFA9020

**SPECIFICATION**

Cabinet lock  
Size: 19X22mm  
Finish: Nickel plated



**Product Code**  
LICFA9021

**SPECIFICATION**

Cabinet lock  
Size: 19X32mm  
Finish: Nickel



**Product Code**  
LICFA9022

**SPECIFICATION**  
Mail box lock  
Size: 19X25mm  
Finish: Nickel



**Product Code**  
LICFA9023

**SPECIFICATION**  
Glass door lock  
Size: 19X20mm  
Finish: Chrome





## GLASS FITTINGS

LOCKRON glass fittings offers the perfect product mix for creating the aesthetically pleasing toughened glass doors assemblies. It gives designers the wings to express their ideas and bring it to reality.

Being produced with the highest quality of materials along with effortless simple glass preparation and longevity, LOCKRON glass fittings is the ideal choice for our customers.

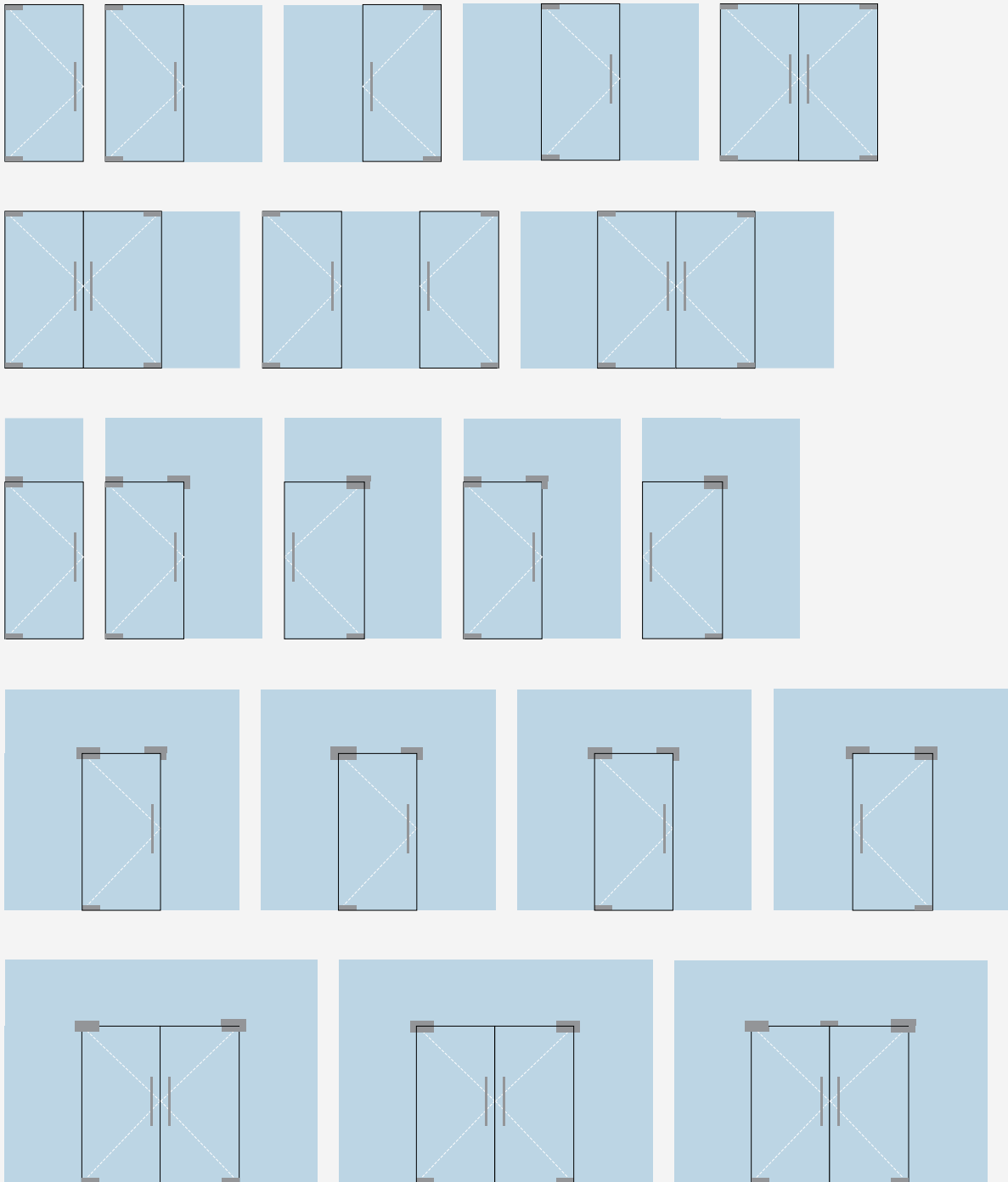

**PATCH FITTING**

GLASS FITTING

**GLASS FITTINGS**

LOCKRON offers patch fittings for doors, sidelites and overpanels, providing designers and architects a complete range of products and solution for toughened frameless glass door assemblies.

**SPECIFICATION**

- Maximum door width 1000mm
- Door thickness 10mm - 12mm
- Suits floor springs with German Spindle - SS304 stainless steel grade covers
- High quality aluminium castings
- Gaskets to suit 10mm and 12mm glass thickness

**APPLICATION**

- For internal and external glass door assemblies
- Suitable for single action and double action doors

**FINISHES**

SSS	Satin stainless steel
PSS	Polished stainless steel

\*Special finish available upon request subject to minimum order quantity

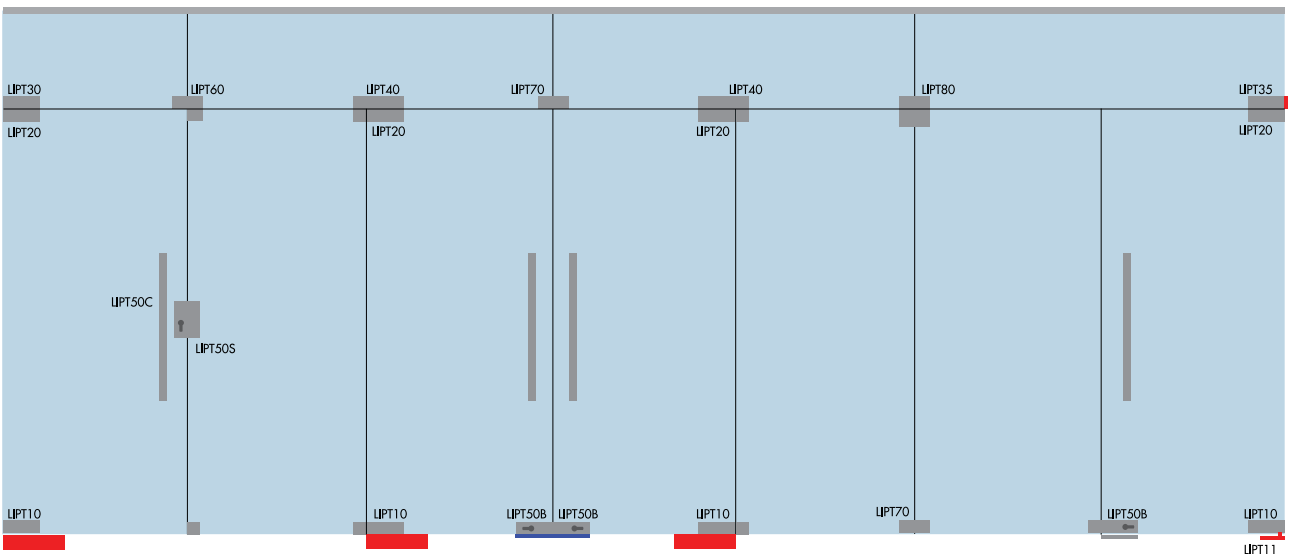

**BOTTOM PATCH**

LIPT10

Bottom patch with insert to suit German spindle floor springs

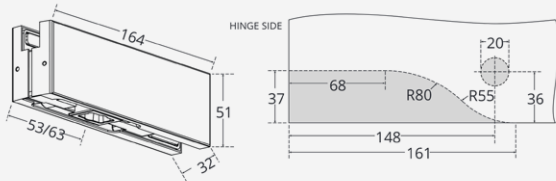

**TOP PATCH**

LIPT20

Top patch with socket for 15mm dia pivot

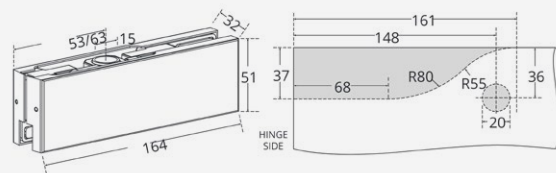

**OVERPANEL PATCH**

LIPT30

Overpanel patch with 15mm dia pivot

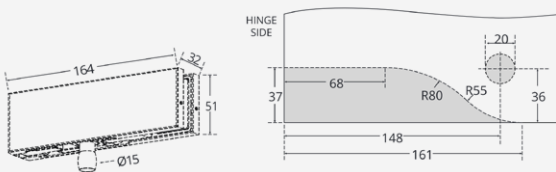

**PATCH FITTING**

GLASS FITTING

**OVERPANEL PATCH WITH WALL CONNECTOR**

LIPT35

Overpanel patch with wall connecting plate with 15mm dia pivot

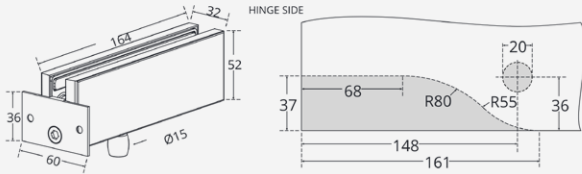

**OVERPANEL AND SIDE PANEL CONNECTOR**

LIPT40

Overpanel and side panel connecting patch with 15mm dia pivot

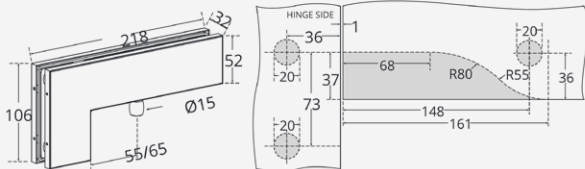

**OVERPANEL AND SIDE PANEL CONNECTOR**

LIPT60

Overpanel and side panel connecting patch with blank inserts

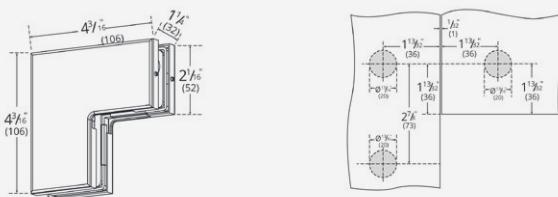

**Overpanel Connector**

LIPT70

Overpanel connector patch with blank inserts

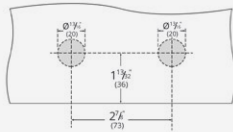
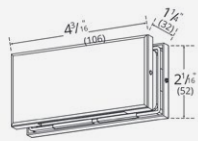

**QUADRUPLE CONNECTOR**

LIPT80

Four way glass connector

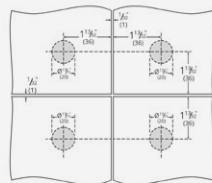
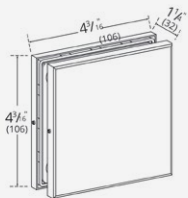

**CORNER LOCK**

LIPT50B

Corner lock with euro profile cylinder and suitable strike plate with 20mm deadbolt projection

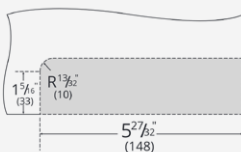
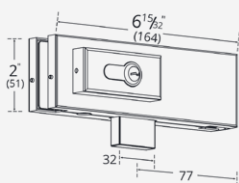

**PATCH FITTING**

GLASS FITTING

**CENTER LOCK**

LIPT50C

Center lock with euro profile cylinder with 20mm deadbolt projection

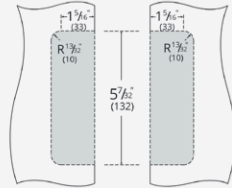
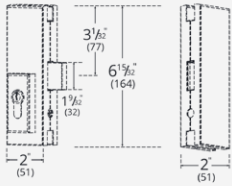

**STRIKE BOX**

LIPT50S - Single door strike box  
LIPT50DS - Double door strike box

Strike box to suite LIPT50C center lock

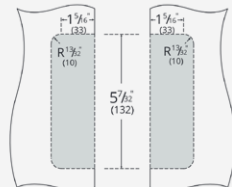
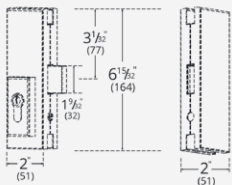

**PIVOT**

LIPT24

15mm dia pivot with 3mm fixing plate



**FLOOR PIVOT BEARING**

LIPT11

Floor pivot bearing with 3 fixing holes 150kg weight capacity



**BLANK INSERTS**

LIPT12

Blanking Inserts suitable for LIPT30/35/40

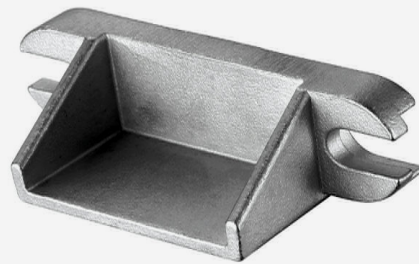

**STOP INSERTS**

LIPT13

Stopping Inserts suitable for LIPT30/35/40



## PULL HANDLES

### FEATURES

- Manufactured from highest grade Stainless Steel SS304
- Heavy duty inserts for long lasting durability
- Adheres to the guidelines of BS 8300
- One package suitable for Wood, Metal, Glass and Aluminum doors Supplied with suitable screws and fixings

### AVAILABLE FIXINGS

- Back to back fixing
- Bolt Thru fixing
- Concealed fixing
- Rose Fixing

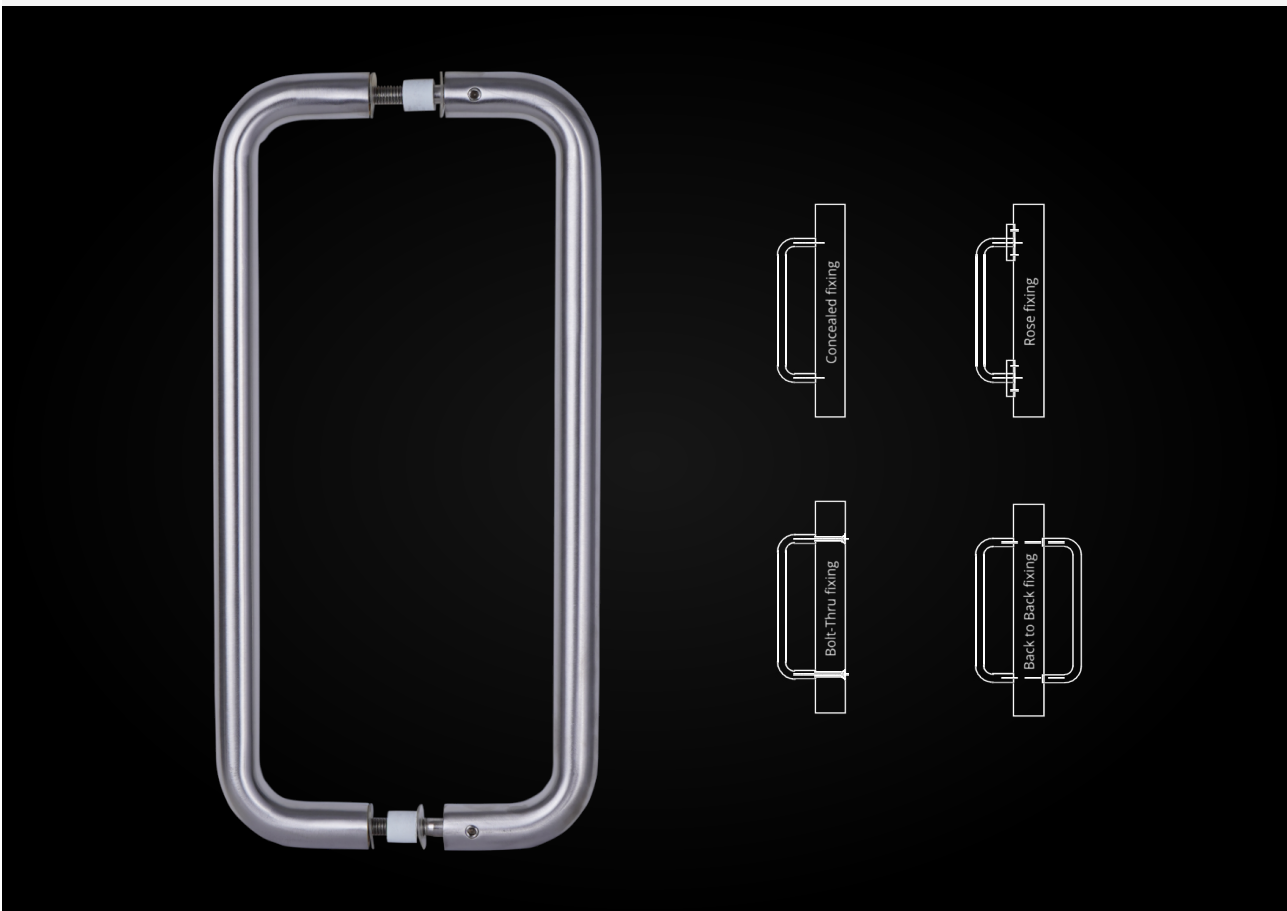

### FINISHES

SSS	Satin stainless steel
PSS	Polished stainless steel
PVDB	PVD Black
PVDG	PVD Gold

\*Special finish available upon request  
\*SS316 available upon request

**PRODUCT CODE**

Code	Length	Diameter
LIPD150A	150mm	19mm
LIPD225A	225mm	19mm
LIPD300A	300mm	19mm
LIPD300B	300mm	22mm
LIPD300E	300mm	25mm
LIPD300C	300mm	32mm
LIPD425B	425mm	22mm
LIPD425E	425mm	25mm
LIPD425C	425mm	32mm
LIPD600B	600mm	22mm
LIPD600E	600mm	25mm
LIPD600C	600mm	32mm

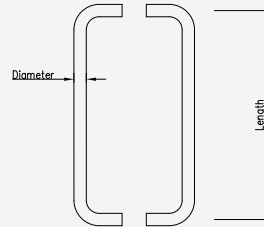

**PRODUCT CODE**

Code	Length	CTC	Diameter
LIPH350B	350mm	250mm	22mm
LIPH450B	450mm	350mm	22mm
LIPH450C	450mm	350mm	32mm
LIPH525B	525mm	425mm	22mm
LIPH700C	700mm	600mm	32mm
LIPH800C	800mm	700mm	32mm
LIPH1000C	1000mm	850mm	32mm
LIPH1500D	1500mm	1300mm	38mm
LIPH2000D	2000mm	1800mm	38mm

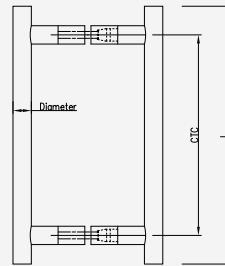

**PRODUCT CODE**

Code	Length	CTC	Diameter
LIPHSQ450E	450mm	300mm	25mm
LIPHSQ600E	600mm	450mm	25mm
LIPHSQ775E	775mm	600mm	25mm
LIPHSQ1000E	1000mm	800mm	25mm
LIPHSQ1200E	1200mm	1000mm	25mm
LIPHSQ1600E	1600mm	1400mm	25mm
LIPHSQ1800E	1800mm	1600mm	25mm

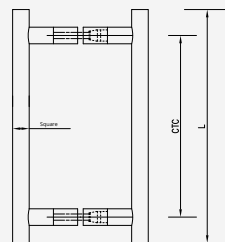

**PULL HANDLES**

GLASS FITTING

**PRODUCT CODE**

Code	Length	Square
LIPMSQ225F	225mm	20mm
LIPMSQ300F	300mm	20mm
LIPMSQ450F	450mm	20mm
LIPMSQ600F	600mm	20mm
LIPMSQ225E	225mm	25mm
LIPMSQ300E	300mm	25mm
LIPMSQ450E	450mm	25mm
LIPMSQ600E	600mm	25mm

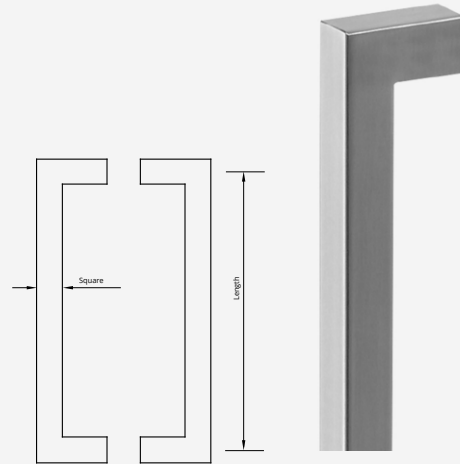

**PRODUCT CODE**

Code	Length	Thickness	Width
LIPMR450X	450mm	15mm	30mm
LIPMR600X	600mm	15mm	30mm
LIPMR800X	800mm	15mm	30mm
LIPMR450Y	450mm	20mm	40mm
LIPMR600Y	600mm	20mm	40mm
LIPMR800Y	800mm	20mm	40mm

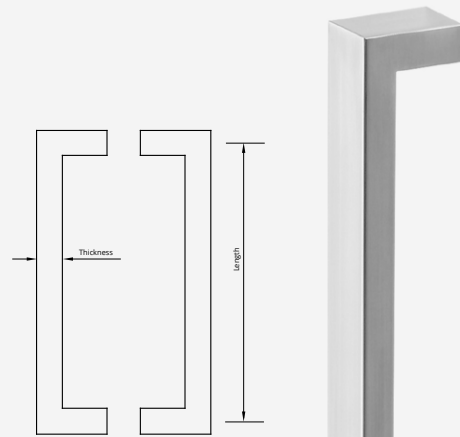

**PRODUCT CODE**

Code	Length	Square
LIOPMSQ300E	300mm	25mm
LIOPMSQ450E	450mm	25mm
LIOPMSQ600E	600mm	25mm

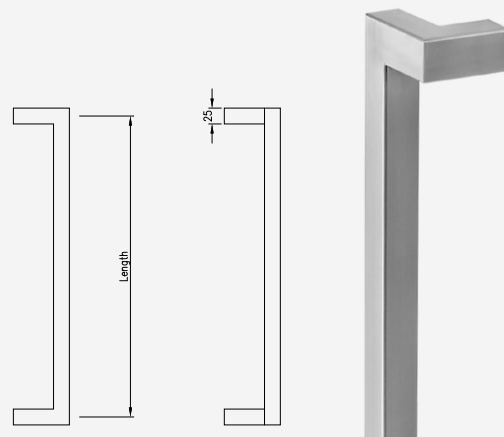

**PRODUCT CODE**

Code	Length	Diameter
LIOPD300E	300mm	25mm
LIOPD450E	450mm	25mm
LIOPD450C	450mm	32mm
LIOPD600C	600mm	32mm
LIOPD800C	8 00mm	32mm

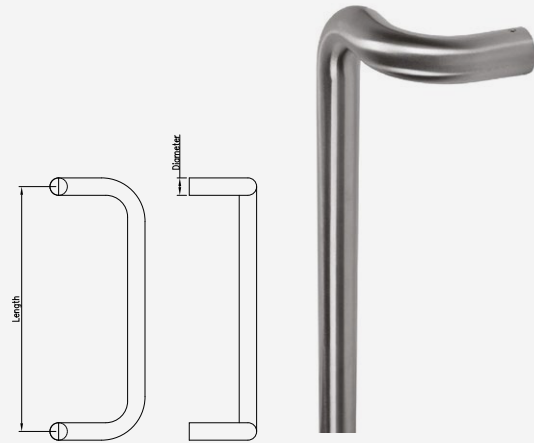

**PRODUCT CODE**

Code	Length	Diameter
LIPM300A	300mm	19mm
LIPM425B	425mm	22mm

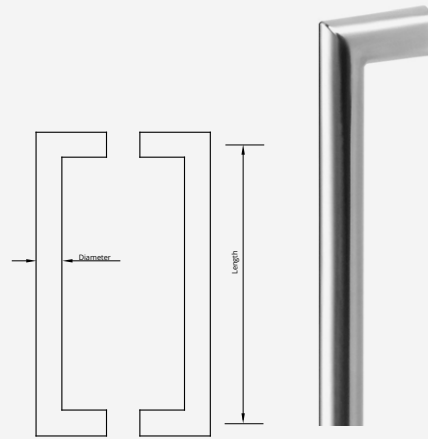

**PRODUCT CODE**

Code	Length	Square
LIPHT600B	600mm	22mm
LIPHT600F	600mm	20mm

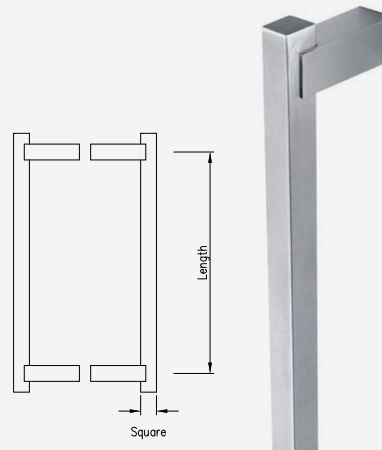

**PULL HANDLES**

GLASS FITTING

**PRODUCT CODE - How to order**

- LIPD \_\_\_ 300A (300 CTC, 19mm dia)
- BS 225A (225 CTC, 19mm dia)
- CS 300B (300 CTC, 22mm dia)
- RS 300E (300 CTC, 25mm dia)
- 450C (450 CTC, 32mm dia)
- 600E (600 CTC, 25mm dia)
- 600C (600 CTC, 32mm dia)
- 800C (800 CTC, 32mm dia)

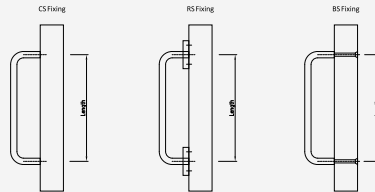

**PRODUCT CODE - How to order**

- LIPH \_\_\_ 300A (300 CTC, 400 L, 19mm dia)
- BS 300B (300 CTC, 400 L, 22mm dia)
- CS 350C (350 CTC, 450 L, 32mm dia)
- RS 600B (600 CTC, 700 L, 22mm dia)
- 600C (600 CTC, 700 L, 32mm dia)

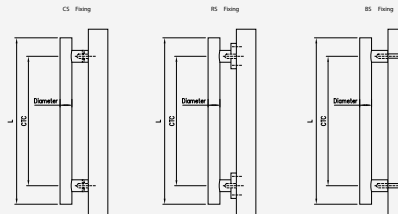

## LOCKABLE PULL HANDLE

H-type lockable pull handle with back to back fixing

### PRODUCT CODE

LIPL1500

### APPLICATION

For internal and external glass door assemblies

### DIMENSION

Diameter 35mm  
CTC 1125mm  
Overall length 1500mm

### SPECIFICATION

H-type lockable pull handle with back to back fixing with one side key and one side thumb turn  
Heavy duty inserts for long lasting durability  
Manufactured from Stainless steel SS304 grade To suit glass thickness of 10mm - 12mm  
Suitable for glass door applications  
Supplied with suitable screws and fixings

### QUALITY AND PERFORMANCE

Successfully inhouse type tested for conformity to all the requirements of BS EN1154

### FINISHES

SSS	Satin Stainless Steel
PSS	Polished Stainless Steel
BLK	Black

\*Special finish available upon request subject to minimum order quantity

\*Custom sizes available upon request subject to minimum order quantity



For flush doors

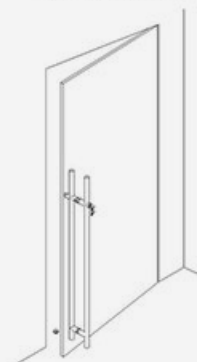

For sliding doors

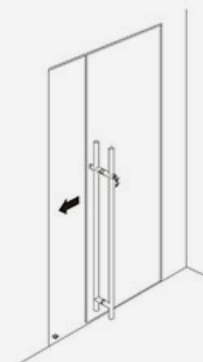

## FLOOR SPRING

LIF7300 series EN 6 fixed size floor spring

### PRODUCT CODE

LIF7300

Closing Force 6  
Door width mm 1400  
Door weight Kg 300

### DIMENSION

Length : 341 mm  
Width : 78 mm  
Depth : 60 mm

### SPECIFICATION

Fixed Spring power EN 6  
Cam action technology offering a much lower opening resistance while delivering optimum closing force and control  
Suitable for door width 1400mm  
Non-handed design with adjustable closing speed and latching speed  
Maximum door opening angle 180 degrees  
90 degrees hold open as default  
Supplied with suitable screws and fixings

### QUALITY AND PERFORMANCE

Successfully inhouse type tested for conformity to all the requirements of BS EN1154

### FINISHES

SSS	Satin Stainless Steel
PSS	Polished Stainless Steel

\*Special finish available upon request subject to minimum order quantity

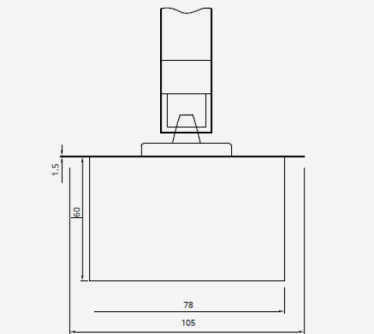
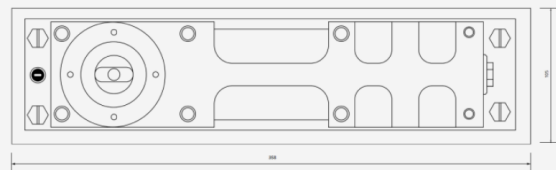

## FLOOR SPRING

LIF7000 series EN 3/4/5 fixed size floor spring

PRODUCT CODE	LIF7003	LIF7004	LIF7005
Closing Force	3	4	5
Door width mm	950	1100	1250
Door weight Kg	100	120	150

### DIMENSION

Length : 324mm

Width : 108mm

Depth : 41mm

### SPECIFICATION

Fixed Spring power EN 3/4/5

Cam action technology offering a much lower opening resistance while delivering optimum closing force and control

Suitable for door widths 950/1100/1250mm Non-handed design with adjustable closing speed and latching speed

Maximum door opening angle 130 degrees

90 degrees hold open as default

Supplied with suitable screws and fixings

### QUALITY AND PERFORMANCE

Successfully inhouse type tested for conformity to all the requirements of BS EN1154

### FINISHES

SSS	Satin Stainless Steel
PSS	Polished Stainless Steel

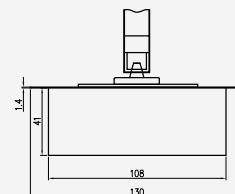
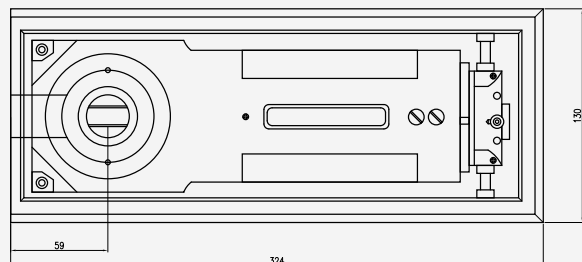

## GLASS DOOR LOCKS

Glass Door Locks for internal glass door assemblies

### PRODUCT CODE – HOW TO ORDER

LIGL (LF) R (LH) (SO)  
01 001 SB  
02 003 SP

### (LF) LOCK FUNCTION

01 – Passage  
02 – Entrance

### (LH) Lever Handle

001 – Mitred  
003 – RTD

### (SO) Strike Option

SB – Strike Box  
SP – Strike Plate

Example: **LIGL02R003SP** for Entrance function round design with RTD lever handle and strike plate

### SPECIFICATION

Glass door lock with Passage and Entrance function  
Optional lever handle designs  
Silent latch with cushioning for quiet operation  
Suitable for Glass to Glass with SB strike box and  
Glass to Wall with SP strike plate  
To suit glass thickness of 8-12mm  
Manufactured from Stainless steel SS304 grade  
Supplied with suitable screws and fixings

### FINISHES

SSS	Satin Stainless Steel
PSS	Polished Stainless Steel
BLK	Black

\*Special finish available upon request subject to minimum order quantity

LIGL01R - Passage



LIGL02R - Entrance

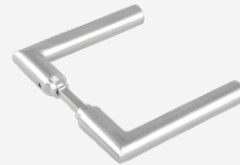

001 – Mitred Design



003 – RTD Design



SP – Strike Plate



SB – Strike Box

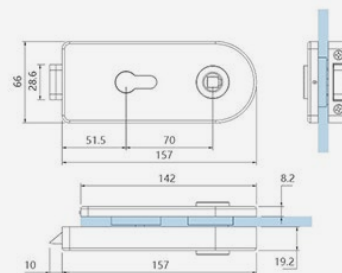
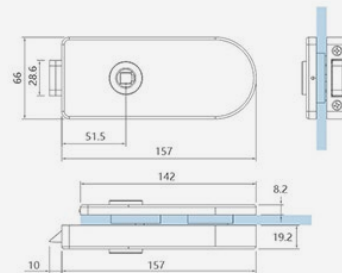

## GLASS DOOR LOCKS

Glass Door Locks for internal glass door assemblies

### PRODUCT CODE – HOW TO ORDER

LIGL03

### SPECIFICATION

Glass door lock with Mortise Sash lock – 72mm CTC and 55mm backset  
 Mitred lever handle design  
 Suitable for Glass to Wall with strike plate  
 To suit glass thickness of 10-12mm Manufactured from Stainless steel SS304 grade Supplied with suitable screws and fixings

### FINISHES

SSS	Satin Stainless Steel
PSS	Polished Stainless Steel
BLK	Black

\*Special finish available upon request subject to minimum order quantity

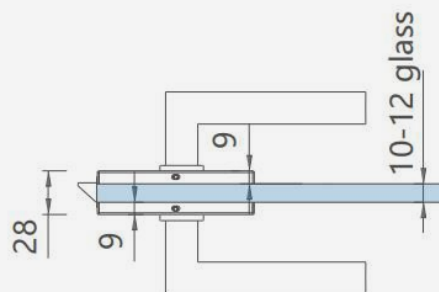
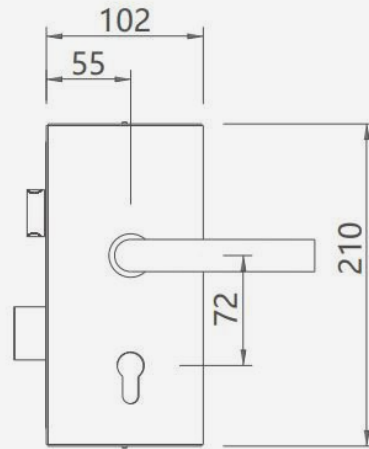

## GLASS DOOR HINGE

Glass door hinge for wooden and Metal door frame

**PRODUCT COD**  
LIGH2535

**Application**  
For internal glass door assemblies

**DIMENSION**  
Width – 60mm  
Height – 86mm

**SPECIFICATION**  
Glass door hinge for wooden and Metal door frame  
Maximum door width 900mm  
Maximum door weight 60kg  
Manufactured from Stainless steel SS304 grade  
To suit glass thickness of 8mm - 10mm Suitable for glass door applications Supplied with suitable screws and fixings

### FINISHES

SSS	Satin Stainless Steel
PSS	Polished Stainless Steel
BLK	Black

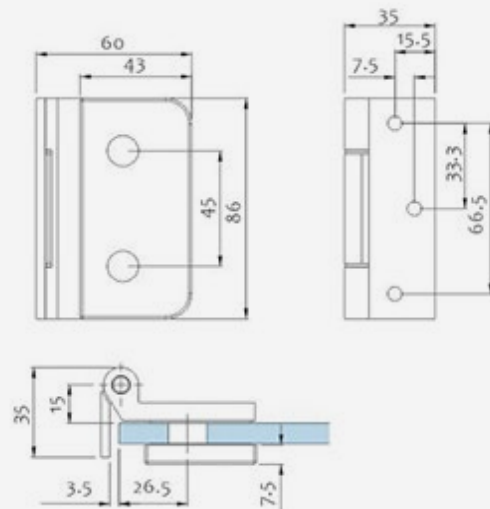

## GLASS DOOR PIVOT

Glass door pivot manet system for internal glass door assemblies

### PRODUCT COD

LIGH4638

### Application

For internal glass door assemblies

### SPECIFICATION

Glass door pivot manet system - Handed Need to specify Handing – LH or RH Maximum door width 950mm Maximum door weight 200kg To suit glass thickness of 10mm - 12mm Suitable for glass door applications Supplied with suitable screws and fixings

### FINISHES

P+SSS	Painted + Satin Stainless Steel
P+PSS	Painted + Polishes Stainless Steel

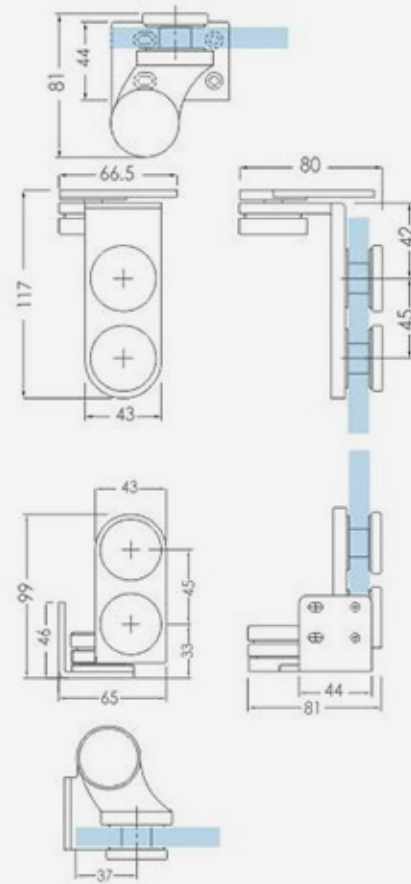

## SHOWER FITTING

### SPECIFICATION

- High quality shower hinges and glass connectors
- Minimum Gap between glass and wall fixings with secured holdings
- For 8-12mm toughened glass
- Available in Stainless steel 304 & 316 grade
- Supplied with gaskets and fixing accessories thickness

### FINISHES

SSS	Satin finish
PSS	Polished finish

\*Special finish available upon request subject to minimum order quantity



**90° WALL TO GLASS SINGLE SIDE**  
LISH201SS



**90° WALL TO GLASS DOUBLE SIDE**  
LISH202SS



**135° GLASS TO GLASS**  
LISH203SS



**180° GLASS TO GLASS**  
LISH204SS



**90° GLASS TO GLASS**  
LISH205SS



**SHOWER HINGES**

GLASS FITTING

**90° WALL TO GLASS SINGLE SIDE**  
LISH301SS



**90° WALL TO GLASS DOUBLE SIDE**  
LISH302SS



**135° GLASS TO GLASS**  
LISH303SS



**180° GLASS TO GLASS**  
LISH304SS



**90° GLASS TO GLASS**  
LISH305SS



**WALL TO GLASS CONNECTOR**  
LIGC401



**90° WALL TO GLASS CONNECTOR**  
LIGC402



**90° GLASS TO GLASS CONNECTOR**  
LIGC403



**180° WALL TO GLASS CONNECTOR**  
LIGC404



**180° GLASS TO GLASS CONNECTOR**  
LIGC405



## SHOWER FITTINGS

**PRODUCT CODER**  
LISA2001

**Application**  
For internal glass door assemblies

**FINISHES**

SSS	Satin Stainless Steel
PSS	Polished Stainless Steel
BLK	Black

\*Special finish available upon request subject to minimum order quantity

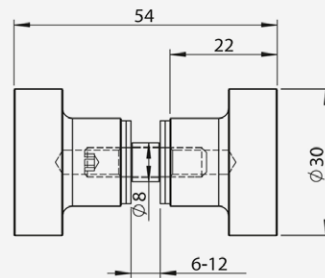
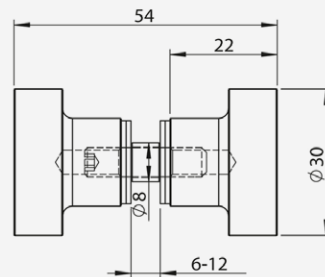

## SHOWER FITTINGS

**PRODUCT CODER**  
LISA2002

**Application**  
For internal glass door assemblies

**FINISHES**

SSS	Satin Stainless Steel
PSS	Polished Stainless Steel
BLK	Black

\*Special finish available upon request subject to minimum order quantity

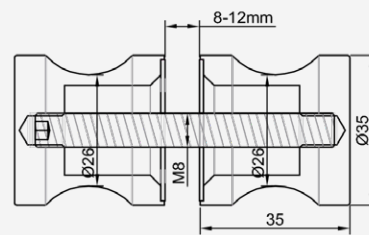

## SHOWER FITTINGS

**PRODUCT CODER**  
LISA2003

**Application**  
For internal glass door assemblies

**FINISHES**

SSS	Satin Stainless Steel
PSS	Polished Stainless Steel
BLK	Black

\*Special finish available upon request subject to minimum order quantity

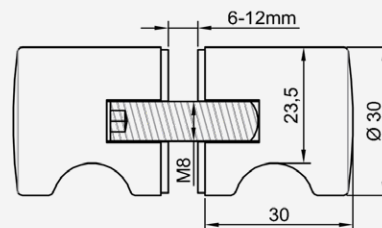

## SHOWER FITTINGS

**PRODUCT CODER**  
LISA2004

**Application**  
For internal glass door assemblies

**FINISHES**

SSS	Satin Stainless Steel
PSS	Polished Stainless Steel
BLK	Black

\*Special finish available upon request subject to minimum order quantity

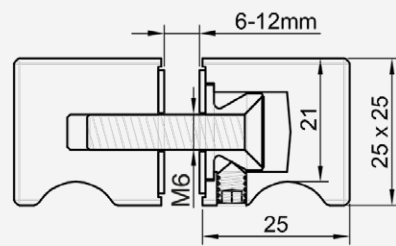
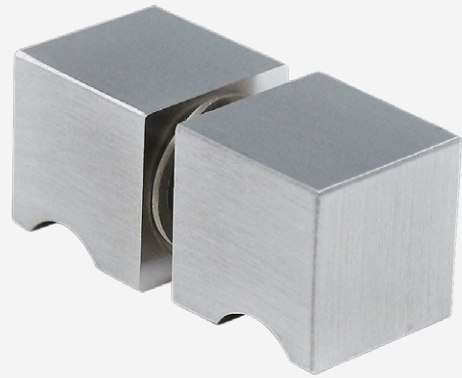

## SHOWER FITTINGS

### PRODUCT CODE

LISA2005

### APPLICATION

For internal glass door assemblies

### DIMENSION

Diameter	25mm
CTC	425mm
Height	150mm
Overall length	450mm

### SPECIFICATION

D-type shower handle with back to back fixing  
 Heavy duty inserts for long lasting durability  
 Manufactured from Stainless steel SS304 grade  
 Suitable for glass door applications  
 Supplied with suitable screws and fixings

### FINISHES

SSS	Satin Stainless Steel
PSS	Polished Stainless Steel
BLK	Black

\*Special finish available upon request subject to minimum order quantity

\*Custom sizes available upon request subject to minimum order quantity

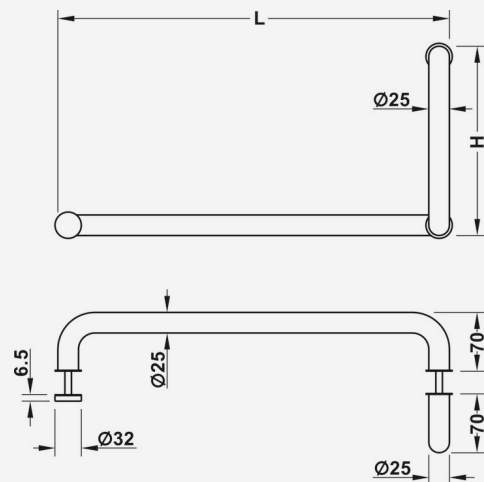

## SHOWER FITTINGS

### PRODUCT CODE

LISA2006

### APPLICATION

For internal glass door assemblies

### DIMENSION

Diameter 25mm  
CTC 425mm  
Overall length 450mm

### SPECIFICATION

D-type shower handle with back to back fixing  
Heavy duty inserts for long lasting durability  
Manufactured from Stainless steel SS304 grade  
Suitable for glass door applications  
Supplied with suitable screws and fixings

### FINISHES

SSS	Satin Stainless Steel
PSS	Polished Stainless Steel
BLK	Black

\*Special finish available upon request subject to minimum order quantity  
\*Custom sizes available upon request subject to minimum order quantity

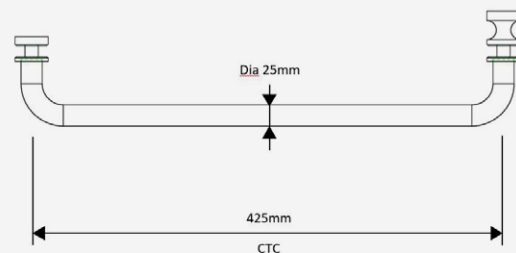





L

O

C

K

**LOCKRON** ARCHITECTURAL  
HARDWARE (UK) LTD

**Kemp House 160 City Road**  
London  
EC1V 2NX  
United Kingdom

R

O

N

www.lockron.com

 **LOCKRON**  
From Entries To Exits